



iMotor
electric motors

BRUSHLESS MOTORS

TECHNICAL CATALOGUE



BRUSHLESS
MOTORS

BRUSHLESS MOTORS

N° 1305.1-05/16 Poles 8

Mot. 3 ph.- Type ZEPH 56b8 B3

2,3 kg I.C.L. F (ΔT B) IP 55 S 1

Execution IC 411

V _{drive}	kW	A _{rms}	rpm
400	0,09	0,20	1500
400	0,12	0,25	3000

Produced by iMotor

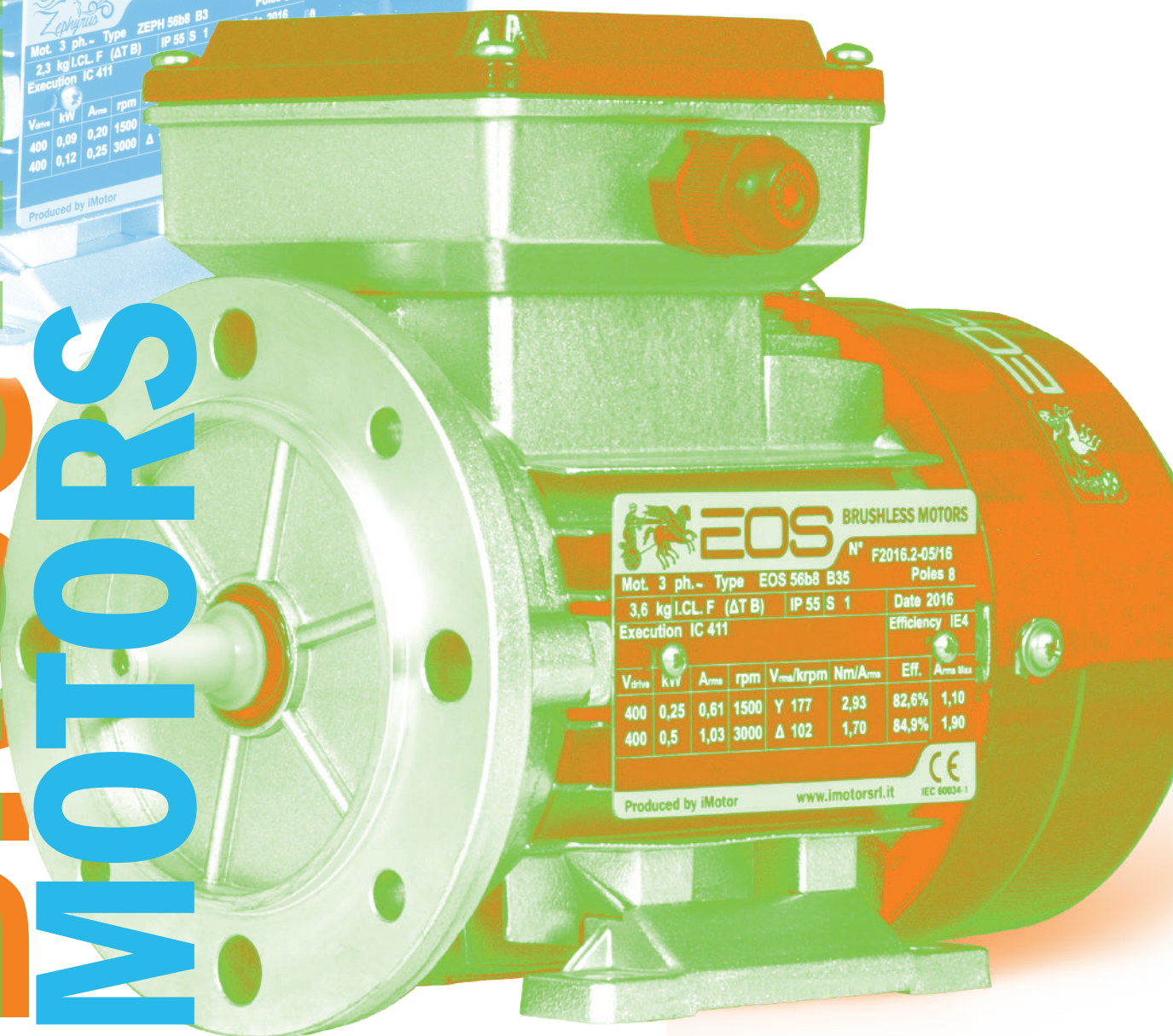

EOS BRUSHLESS MOTORS

N° F2016.2-05/16 Poles 8

Mot. 3 ph.- Type EOS 56b8 B35

3,6 kg I.C.L. F (ΔT B) IP 55 S 1 Date 2016

Execution IC 411 Efficiency IE4

V _{drive}	kV	A _{rms}	rpm	V _{rms} /krpm	Nm/A _{rms}	Eff.	A _{rms} Size
400	0,25	0,61	1500	Y 177	2,93	82,6%	1,10
400	0,5	1,03	3000	Δ 102	1,70	84,9%	1,90

Produced by iMotor www.imotorsrl.it IEC 60034-1



BRUSHLESS MOTORS

Responsibilities concerning products and their use

The Customer is responsible for the correct selection and use of the product in relation to its industrial and/or commercial needs.

The Customer is always responsible for security in the application of the product.

In drawing up the catalogue, the utmost attention was paid to ensure the accuracy of the information. However, Seipee cannot accept direct or indirect liability for any errors, omissions or outdated data.

Due to constant developments, Seipee reserves the right to make changes at any time to the content of this document that in any case should NEVER be considered binding.

The Customer is ultimately responsible for the choice of product, unless otherwise duly formalised in writing and signed by the parties.

MEMBER OF ANIE and CONFINDUSTRIA

Seipee is a member of ANIE (National Federation of Electrotechnical and Electronic Companies), a division of the electrotechnical and electronic sector of Confindustria that is considered a reference in terms of every technical aspect in its sector and regulations in force

The Energy association, founded on the merger of Production, Transmission and Distribution Industries, has gained the necessary weight over time to become the interlocutor with national and international institutions for all issues with the aim of promoting greater rationality and efficiency of the system for the user's benefit. The competence to deal with any problem relating to the energy sector is the foundation of the association that

CE conformity

iMotor products comply with the applicable Product Directives as required in all countries of the European Community, to ensure an appropriate safety standard. An "EC declaration of conformity" is issued for each product relating to the following directives: 2006/95/EC "Low Voltage Directive".

Compliance with directives and regulations. iMotor motors comply with the requirements of the CEI EN 60034 standards for rotating electrical machines and the following directives for which the EC mark is applied on the plate:

- Directive 2014/35/EU: Low Voltage Directive
- Directive 2014/30/EU: Electromagnetic Compatibility Directive (EMC)

All iMotor motors comply with the requirements of the Machinery Directive (2006/42/EC). According to this Directive, electric motors are components and are solely intended for integration into other machines. The motor can only be put into service after certification, by the end user, of the machine to which the motor is applied.



makes it the centre of the professional, industrial and commercial interests of members, to encourage a more open and aware dialogue with customers all around the world, in compliance with the legislation.

In this context, members guarantee the customer a wide pre-sales consultation, a complete range of products manufactured according to the standards of quality and environmental impact and after-sales support to provide prompt answers to the user's service needs.



Content

	Page
Conformity with directives and standards	
1. The made in Italy solution that combines ease of use and high technology	6
2. Economic advantages with the use of Eos and Zephyrus motors	7
2.1. Work efficiently	7
2.2. Calculation of energy savings and costs	7
3. General characteristics	9
3.1. Variation of the power yielded according to the ambient temperature	9
3.2. Variation of the power yielded according to the altitude	9
4. How to order a motor	10
5. Eos motors range	12
6. Zephyrus Motors range	15
7. Plate	16
8. Definition of the main sizes	17
8.1. Revs torque curve according to the ventilation applied to the motor	18
9. Electrical connections by size up to an axis height 160L	52
10. Electrical connections by size with axis height FROM 180L and higher	52
11. Electrical connections - Warnings	52
12. Dimensions and standardized	52
12.1. Construction forms and assembly positions	53
13. Possible motor configurations	59
13.1. Ventilation option	59
13.2. Parking brake option	60
14. Bearings and lubrication	63
14.1. Maximum radial loads applicable	65
14.2. Maximum axial loads applicable	66
15. Dynamic balancing	67
16. Sound levels	68
17. Special executions	70
Safety warnings	74

1. THE MADE IN ITALY SOLUTION THAT COMBINES SIMPLICITY OF USE AND HIGH TECHNOLOGY

The need for energy saving in the most industrialised countries remains a matter of great sensitivity.

Particular attention should be paid to the electrical motors, which account for around 70% of industrial energy consumption. Some directives on electric motors are already in force in this regard and others are ready to be published with increasingly stringent efficiency limits.

For this reason, SEIPEE S.p.A. decided to look ahead and propose on the market an entire range of permanent magnet-based, brushless, sensorless, synchronous electric motors, with a range of power 0.13kW ÷ 24kW and various nominal operating speeds.

Our range of iMotor branded electric motors is capable of meeting levels of efficiency IE4 or "Super Premium Efficiency". Therefore, they allow a considerable reduction in electricity consumption, especially in applications that require many hours of operation.

Recovery of the initial investment is rapid thanks to the high efficiency of permanent magnet electric motors compared to asynchronous ones in all speed and load conditions applied.

The use of rare, ground permanent magnets has allowed the design of brushless IE4 synchronous electric motors with a higher power density than traditional asynchronous motors.

The iMotor branded brushless electric motors are also advantageous in the field of automation or motion control where moderate dynamics and competitive costs are required compared to the standard technologies in the sector for years.

A summary follows of the main benefits this type of motors provides on an industrial panorama:

- **High energy efficiency: IE4 (IEC Technical Specification IEC/TS 60034-31 and draft IEC Standard 60034-30 edition 2)**
- **Constant torque over the whole speed range.**
- **High peak torque values.**
- **Optimised costs and mechanics with proven reliability thanks to use of the mechanical structure tested for years of the asynchronous motor.**
- **Motor speed control in FOC (Field Oriented Control) mode: increased reliability due to the absence of transducers, while maintaining optimised speed control performance.**

Wide range of motor customisation thanks to a wide range of optionals and special parts available, such as different speed sensors that allow precise positioning to be achieved even at very low rotary speeds.

- **The compact EOS range, thanks to a high size-cut ratio, allows reduced weights and dimensions up to two motor sizes compared to the asynchronous solution with the same mechanical size.**
- **The compact ZEPHYRUS range offers a range of motors with the same size-power ratio as asynchronous motors, allowing perfect interchangeability.**



2. ECONOMIC ADVANTAGES WITH THE USE OF EOS AND ZEPHYRUS MOTORS

2.1 Work Efficiency

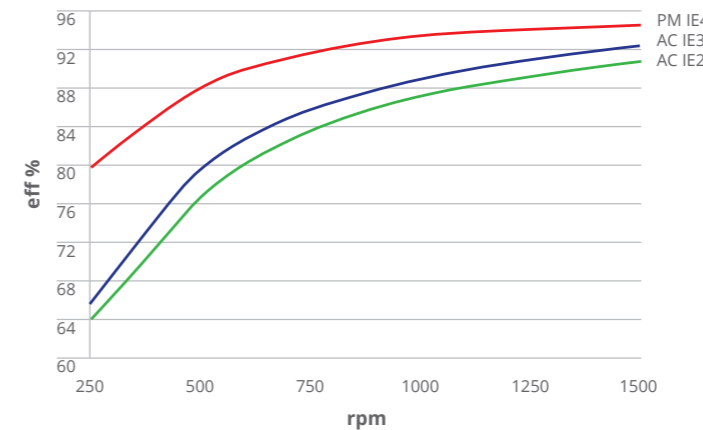

The advantages of high-efficiency motors include:
 Reduction of consumption and costs of electricity;
 Greater efficiency at reduced loads, since constant losses are more contained;
 Greater efficiency for speeds lower than rated.

Example of variation in efficiency by varying the speed for IE2-IE3-IE4 motors

2.2 Calculation of Energy and Costs Savings

Asynchronous motor IE1 or IE2 or IE3:
 Energy used in one year [kWh/year]:

$$E_{asynchronous} = \frac{P_{nom} \times L\%}{\frac{\eta_{asynchronous}}{100}} \times H$$

Annual energy cost [Euro/year]:

$$CA_{asynchronous} = \frac{P_{nom} \times L\%}{\frac{\eta_{asynchronous}}{100}} \times H \times C$$

iMotor motor:

Energy used in one year [kWh/year]:

$$E_{iMotor} = \frac{P_{nom} \times L\%}{\frac{\eta_{iMotor}}{100}} \times H$$

Annual energy cost [Euro/year]:

$$CA_{iMotor} = \frac{P_{nom} \times L\%}{\frac{\eta_{iMotor}}{100}} \times H \times C$$

Savings:

Energy saved in one year [kWh/year]:

$$E = E_{asynchronous} - E_{iMotor}$$

Annual savings [Euro/year]:

$$RA = CA_{asynchronous} - CA_{iMotor}$$

Recovery time for higher motor cost [Months]:

$$TR = \frac{(Pr_{iMotor} - Pr_{asynchronous})}{RA} \times 12$$

Where:

- P_{NOM} [kW]: rated motor power
- L %: Coefficient (%) of use of the rated motor power
- η_{ASINCRONO}: Efficiency (%) of the asynchronous motor (IE1/IE2/IE3)
- η_{iMotor}: Efficiency (%) of the iMotor brushless motor
- H [h/year]: Annual use of the motor
- C [Euro/kWh]: Cost of kWh
- Pr_{ASINCRONO} [Euro]: Asynchronous motor price (IE1/IE2/IE3)
- Pr_{iMotor} [Euro]: iMotor brushless motor price

Schematic diagram for efficiency calculation

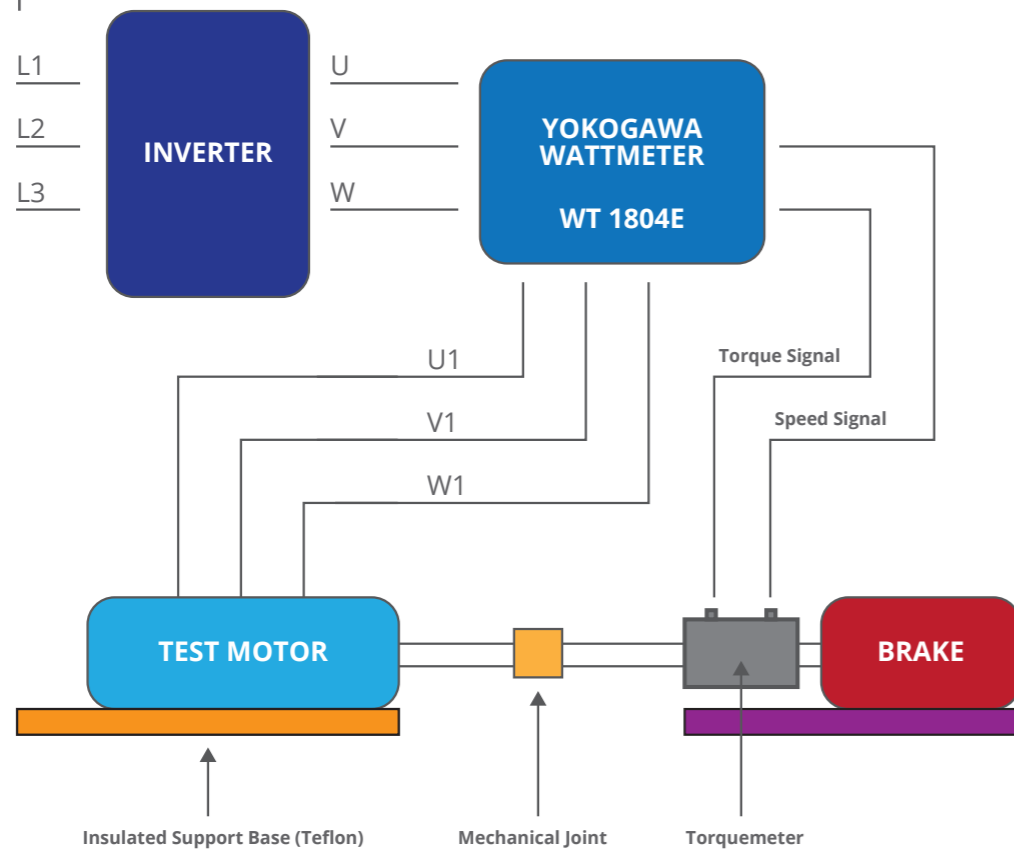

Test Execution Conditions

- **Motor under test:** it is placed under load and at rated speeds without seals on a base that is thermally insulated from the support surface of the brake booster.
- **Wattmeter**
connection: ARON insertion
Inverter power supply filter frequency: 1kHz
Motor power supply filter frequency: 4kHz
Efficiency calculation: mech/sum
- **Frequency converter (inverter):** in FOC (Field Oriented Control) mode, switching frequency 8 kHz

Performance

The efficiency values vary according to the speed and torque load applied. The following catalogue shows the efficiency values for the rated torque/power/speed values.

For yield values of torque/power and speed different to nominal values, contact the SEIPEE S.p.A. technical office.

3. GENERAL CHARACTERISTICS

Permanent magnet three-phase synchronous motors, designed to operate with variable speed drive (VSD). It is **not possible for direct start-up from the mains for the iMotor EOS and ZEPHYRUS series brushless motors.** Supply of the variable speed drive (VSD) to the rated voltage value indicated in the “performance cards” of the motors and a maximum permissible voltage variation of ±5%.

For power supply voltage > 500 V contact the SEIPEE S.p.A. technical office.

Standardized MEC sizes for quick interchangeability with traditional asynchronous motors
Standard speed control in sensorless mode.
Optional: incremental encoder, absolute encoder, resolver.

Operation with the inverter must comply with the following limits:

- **Vnom power supply voltage <500V;**
- **Voltage peaks Upeak<1500V;**
- **Voltage gradients dU/dt<1.5 kV/μs).**

Not suitable for environments with danger of explosion. Designed to operate in continuous service (S1) at rated voltage and frequency, general use in industrial applications, externally ventilated.

Cooling method IC 411, optionally IC 416 or IC 410
Working environment air temperature: -15 ÷ + 40°C with a maximum altitude of 1000m above sea level.

3.1 Variation of the Power Yielded according to the Ambient Temperature

Ambient Air Temperature [°C]	25	30+40	45	50	55	60
P / P _N	1,07	1,00	0,95	0,90	0,85	0,80

3.2 Variation of the Power Yielded according to the Altitude

Altitude above sea level [M]	0+1.000	1.500	2.000	2.500	3.000	3.500	4.000
P / P _N	1,00	0,97	0,93	0,89	0,85	0,80	0,74

Winding: double-enamel copper wire class H, autoclave impregnation with low-solvent content resin, accurate separation of the phase windings with one another and towards the ground with insulating materials with insulation class F with standard overtemperature in class B (optional higher insulation classes and overtemperatures).

Cooling fan: two-directional with radial vanes, fitted on the motor shaft, in reinforced polypropylene.

Suitable for operation for rapid voltage variations produced by the motor control drive (frequency converter).

Body: die cast aluminium alloy from size 56 to 160. Excellent thermal conductivity, excellent corrosion resistance, motor lifting eyebolt with EOS100La6 size.
From size 180 and higher, cast iron body with cast feet.

Over-temperature winding protection: All motors are equipped as standard with thermistor (PTC) thermal probes. The terminals of the probes are inside the terminal box.

Shields and flanges: die cast aluminium alloy, the bearing compartments are reinforced with steel starting from size 112.

Degree of protection of motor casing IP 55: the cooling fan of the motor, outside the body, is protected using a specific fan cover sleeve.

Fastening feet from size 56 to 160, die cast aluminium alloy, with the possibility of assembling the feet on the 3 sides of the motor in order to have the terminal box on the desired side: IM B3, B5,
From size 180 and higher, feet in cast iron firmly on the body.

Terminal box: in die cast aluminium alloy. Adjustable 90° in 90°, standard position at the top and near the control side. Equipped with plastic cable glands supplied as standard on the right side with a view of the shaft output side. Equipped with 6-pin terminal block for star or delta connection and 2 pins for thermal sensor. #1 earth terminal inside the box and #1 external clamp on the casing.

Shaft: 39NiCrMo3 steel, cylindrical ends, threaded hole in head, unified form tab.

Rotor: Magnetic laminated structure with permanent NeFeB magnets. Dynamic balancing of the rotor with half key.

Stator: insulated magnetic laminations with low loss

Bearings: rigid radial bearings with top brand ball crown lubricated for life with lithium grease and working temperature -15÷+110°C, double shield 2RS/DDU – ZZ. No maintenance required for lubrication.

Sealing rings: NBR double lip with spring. They are

assembled on the rear and front of the motor as a standard solution.

Painting: from size 56 to 160 combined nitro paint RAL 9006 (pearl grey) and RAL 9005 (semi-gloss black) from size 180 and above RAL 5001 (blue). Suitable to withstand normal industrial environments and to allow additional finishes with synthetic single-component paints.

Standard rated speeds available: 1500-3000rpm rated speeds different from the standard catalogue values are available optionally, by contacting the iMotor technical office.

EOS and ZEPHYRUS series motors are available on request with UL certification for the US and Canadian market.

Wide availability of special executions on request (see “Special Executions” page 68).

4. HOW TO ORDER A MOTOR

Efficiency	Type	Speed {RPM}	Series	Axis height [mm]	Power Nominal [kW]	Mounting arrangement	Voltage nominal Drive [Vac]
IE4	SPM	3000rpm	EOS	56b	kw 0,5	B3	volt. 400
						B5	
						B6	
						B7	
						B8	
						B14	
						B34	
						B35	
						IM V1	
						IM V3	
						IM V5	
						IM V6	
						IM V15	
						IM V18	
						IM V19	
						IM V36	

NB: For inverter power voltages different from 400V, specify the desired value when ordering.

EXAMPLES OF OPTIONAL NON-STANDARD EXECUTIONS (You can combine multiple options together)	
E01	Resolver
E02	Incremental encoder
E03	Absolute encoder
E04	Encoder with hall effect sensors
T01	Bimetallic thermal probes NC 150°C (PTO)
T02	Temperature sensor (PT100)
T03	Variable resistance silicone temperature sensor (KTY)
T04	Anti-condensation heater
T05	Condensate drain holes
A01	Additional wrapping impregnation
A02	Class H insulation
A03	Tropicalisation
IP56	IP56 protection rating
IP65	Protection rating IP 65
IP66	Degree of protection IP66
F01	24V continuous current brake
F02	230-400V 50Hz AC brake
F03	Manual release lever
F04	IP55 brake protection
R01	Manual rotation
C1	Painting for C1-C2 environments
C3	Painting for C3 environments
C4	Painting for C4 environments
C5L	Painting for C5L environments
C5M	Painting for C5M environments
S01	Terminal box position
P01	Rain cover
UL	UL certified motor

Further information on options in chapter 15 of this catalogue.

5.

EOS MOTOR RANGE*



MODEL	P _{NOM} [kW]	RATED SPEED [rpm]	RATED TORQUE T _{NOM} [rpm]	V _{NOM} STANDARD INVERTER [Vrms]	I _{NOM} MOTOR [Arms]	SPEED TRANSDUCER STANDARD	STANDARD VENTILATION
EOS 56b	0,25	1500	1,6	400	0,67	SENSORLESS	IC411
EOS 56b	0,5	3000	1,6	400	1,16	SENSORLESS	IC411
EOS 63b	0,5	1500	3,2	400	1,25	SENSORLESS	IC411
EOS 63b	1	3000	3,2	400	2,1	SENSORLESS	IC411
EOS 71b	1,1	1500	7	400	2,51	SENSORLESS	IC411
EOS 71b	2,2	3000	7	400	4,5	SENSORLESS	IC411
EOS 80b	1,65	1500	10,5	400	4,0	SENSORLESS	IC411
EOS 80b	3,3	3000	10,5	400	7,0	SENSORLESS	IC411
EOS 90S	2,7	1500	17,2	400	6,5	SENSORLESS	IC411
EOS 90S	5,4	3000	17,2	400	12,0	SENSORLESS	IC411
EOS 90La	3,3	1500	21	400	8,1	SENSORLESS	IC411
EOS 90La	6,6	3000	21	400	14,5	SENSORLESS	IC411
EOS 100La	4	1500	25,7	400	9,9	SENSORLESS	IC411
EOS 100La	8	3000	25,7	400	18,4	SENSORLESS	IC411
EOS 112Ma	7,5	1500	47,7	400	17,3	SENSORLESS	IC411
EOS 112Ma	15	3000	47,7	400	32,0	SENSORLESS	IC411
EOS 132Mb	12	1500	76,4	400	31,8	SENSORLESS	IC411
EOS 132Mb	24	3000	76,4	400	58,8	SENSORLESS	IC411
EOS 160Lb	20,4	1500	130	400	51,5	SENSORLESS	IC411
EOS 160Lb	40,8	3000	130	400	84,2	SENSORLESS	IC411

* EOS motors from size 56 to 180 aluminum housing

EOS MOTOR RANGE*



MODEL	POWER NOMINAL [kW]	NOMINAL COUPLE [rpm]	NOMINAL COUPLE [Nm]	NOMINAL CURRENT [A]	EFFICIENCY [%]	INVERTER POWER SUPPLY [Vac]	WEIGHT [kg]
EOS 200La	30	1000	286,5	57	94,2	400	219
EOS 225Sa	37	1000	353,4	64	94,5	400	284
EOS 225Mb	45	1000	430	77	94,8	400	308
EOS 250Ma	55	1000	525	95,5	95,1	400	383
EOS 280Sa	75	1000	716	131	95,4	400	425
EOS 280Sb	90	1000	859,5	158	95,6	400	501
EOS 280Ma	110	1000	1050,5	193	95,8	400	573
EOS 315Sb	132	1000	1261	235	96,0	400	615
EOS 315La	160	1000	1528	280	96,2	400	843
EOS 355Ma	200	1000	1910	355	96,3	400	941
EOS 355Mb	250	1000	2388	444	96,5	400	1017

MODEL	POWER NOMINAL [kW]	NOMINAL COUPLE [rpm]	NOMINAL COUPLE [Nm]	NOMINAL CURRENT [A]	EFFICIENCY [%]	INVERTER POWER SUPPLY [Vac]	WEIGHT [kg]
EOS 180La	37	1500	236	69,0	95,2	400	209
EOS 200Lb	45	1500	286,5	78	95,4	400	325
EOS 225Sa	55	1500	350	96	95,7	400	387
EOS 250Mb	75	1500	477,5	131	96,0	400	440
EOS 250Mc	90	1500	573	162	96,1	400	440
EOS 280Sb	110	1500	700	195	96,3	400	560
EOS 280Ma	132	1500	840	234	96,4	400	608
EOS 315Sa	160	1500	1019	280	96,4	400	670
EOS 315Mb	200	1500	1273	355	96,7	400	1125
EOS 315Mc	250	1500	1592	444	96,7	400	1220

* EOS motors from size 200 to 355 cast iron housing

EOS MOTOR RANGE*



MODEL	POWER NOMINAL [kW]	NOMINAL SPEED [rpm]	NOMINAL COUPLE [Nm]	NOMINAL CURRENT [A]	EFFICIENCY [%]	INVERTER POWER SUPPLY [Vac]	WEIGHT [kg]
EOS 225Sa	55	3000	175	95,5	95,3	400	298
EOS 225Sb	75	3000	239	131	95,6	400	320
EOS 250Ma	90	3000	286,5	158	95,8	400	377
EOS 250Mb	110	3000	350	190	96,0	400	401
EOS 280Sa	132	3000	420	230	96,2	400	480
EOS 280Sb	160	3000	509	280	96,3	400	515
EOS 280Ma	200	3000	637	390	96,5	400	570
EOS 280Mb	250	3000	796	435	96,5	400	608

* EOS motors from size 200 to 355 cast iron housing

6.

ZEPHYRUS MOTORS RANGE*



MODEL	P _{NOM} [kW]	RATED SPEED [rpm]	RATED TORQUE T _{NOM} [rpm]	V _{NOM} STANDARD INVERTER [Vrms]	I _{NOM} MOTOR [Arms]	SPEED TRANSDUCER STANDARD	STANDARD VENTILATION
ZEPH 56b	0,09	1500	0,57	400	0,2	SENSORLESS	IC411
ZEPH 56b	0,12	3000	0,38	400	0,25	SENSORLESS	IC411
ZEPH 63b	0,18	1500	1,15	400	0,4	SENSORLESS	IC411
ZEPH 63b	0,25	3000	0,8	400	0,5	SENSORLESS	IC411
ZEPH 71b	0,37	1500	2,35	400	0,62	SENSORLESS	IC411
ZEPH 71b	0,55	3000	1,75	400	1,1	SENSORLESS	IC411
ZEPH 80b	0,75	1500	4,8	400	1,7	SENSORLESS	IC411
ZEPH 80b	1,1	3000	3,5	400	2,3	SENSORLESS	IC411
ZEPH 90S	1,1	1500	7	400	2,6	SENSORLESS	IC411
ZEPH 90S	1,5	3000	4,8	400	3,1	SENSORLESS	IC411
ZEPH 90L	1,5	1500	9,55	400	3,3	SENSORLESS	IC411
ZEPH 90L	2,2	3000	7	400	4,5	SENSORLESS	IC411
ZEPH 100L	2,2	1500	14	400	4,9	SENSORLESS	IC411
ZEPH 100L	3	3000	9,55	400	6,2	SENSORLESS	IC411
ZEPH 112M	4	1500	25,5	400	8,9	SENSORLESS	IC411
ZEPH 112M	5,5	3000	17,5	400	11,1	SENSORLESS	IC411
ZEPH 132M	7,5	1500	47,8	400	18,4	SENSORLESS	IC411
ZEPH 132M	11	3000	35	400	24,1	SENSORLESS	IC411
ZEPH 160M	11	1500	70	400	26,5	SENSORLESS	IC411
ZEPH 160L	18,5	3000	58,9	400	38,2	SENSORLESS	IC411

* ZEPHYRUS motors from size 56 to 160 aluminum housing

7. PLATE

The following are examples of plates of the EOS and ZEPHYRUS motor range

iMotor		by Seipée					
41011 Campogalliano (MO)		N° ZEPH0000001					
Mot. 3 ph. ~ Type	ZEPH 90La6 B14	Poles	6				
10,3kg I.C.L.F (ΔT B)	IP55 S 1	Date	01/18				
Execution IC 411	Efficiency IE4						
V _{drive}	kW	A _{rms}	rpm	V _{rms} /krpm	Nm/A _{rms}	Eff.	A _{rms max}
400	1,5	3,3	1500	Y192	3,17	89,3%	14,0
400	2,2	4,5	3000	Δ111	1,84	91,2%	24,2

iMotor		by Seipée					
41011 Campogalliano (MO)		N° ZEPH0000004					
Mot. 3 ph. ~ Type	ZEPH 90La6 B14	Poles	6				
10,3kg I.C.L.F (ΔT B)	IP55 S 1	Date	01/18				
Execution IC 411	Efficiency IE4						
V _{drive}	kW	A _{rms}	rpm	V _{rms} /krpm	Nm/A _{rms}	Eff.	A _{rms max}
400	1,5	3,3	1500	Y192	3,17	89,3%	14,0
400	2,2	4,5	3000	Δ111	1,84	91,2%	24,2

- 1 Production order, serial number, month and year of production
- 2 Description of the motor ordered as described in chapter 4 of this technical catalogue
- 3 Number of motor poles
- 4 List of the constructive characteristics of the motor
- 5 Rated power supply voltage of the motor driving inverter [Vrms]
- 6 Rated power available at the motor shaft [kW]
- 7 Rated phase current absorbed by the motor [Arms]
- 8 Rated crankshaft speed [rpm]
- 9 Motor voltage constant (Ke) in [Vrms/krpm] (see definition in paragraph 8.1 of this catalogue)
- 10 Motor torque constant (Kt) in [Nm/Arms] (see definition in paragraph 8.1 of this catalogue)
- 11 Efficiency of the motor at rated power and rated speed
- 12 Maximum overload current applicable to the motor [Arms]
- 13 Motor efficiency class

8. DEFINITIONS OF MAIN DIMENSIONS

• **Rated torque (Tn):** Torque available on the shaft continuously (service S1) at rated speed and rated current; it is measured in [Nm].

• **Maximum torque (Ts):** Torque available on the shaft for limited periods of time, with current equal to its maximum value; it is measured in [Nm].

• **Rated current (In):** Current supplied to the motor continuously at rated speed, in order to develop the rated torque (Tn); it is measured in [Arms].

• **Current at maximum torque (Is):** Current supplied to the motor for limited periods of time in a wide range of speeds, in order to develop the maximum torque (Ts); it is measured in [Arms].

• **Voltage constant (Ke):** voltage generated in the windings by rotor rotation at 1000rpm; measured in [Vrms/rpm].

• **Torque constant (Kt):** Ratio between the torque developed on the shaft and the RMS current value; it is measured in [Nm/Arms].

NB: For maximum current values higher than those indicated on the catalogue, contact the SEIPEE S.p.A. technical office.

8.1 | Rotations Torque Curves – Rotations Power

For every motor size, in the following catalogue, the TORQUE/SPEED and POWER/SPEED graphs are shown considering self-ventilated motors (standard supply).

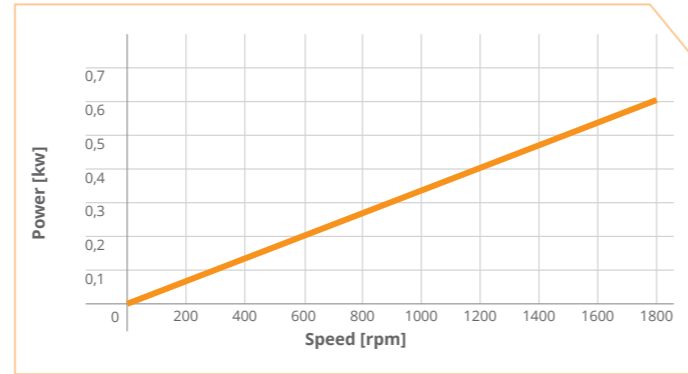
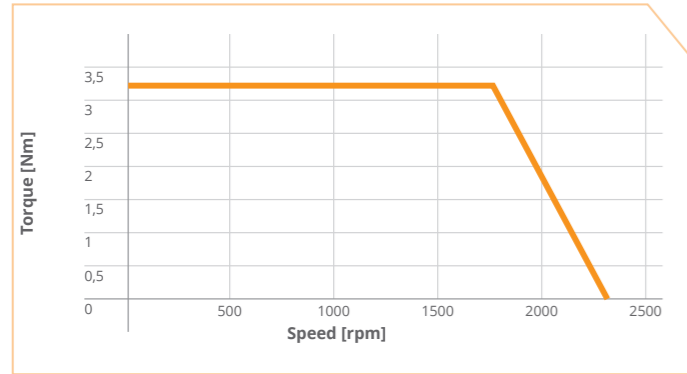

For information on the performance in configuration IC410 and IC416 contact the SEIPEE S.p.A. technical office.





EOS 56b8

Inverter power supply 400 V

MOTOR IC411 (auto-ventilated)

0,25 kW

0,5 kW

Description	Symbol	Unit of measure	RATED SPEED (n_n)	
			1500 rpm*	3000 rpm*
ALUMINUM HOUSING				
Frequency	f	[Hz]	100	200
Number of Poles	p		8	8
Maximum speed	n_{MAX}	[rpm]	2300	4000
Voltage constant (connected) $\pm 5\%$	K_e	[Vrms/krpm]	173(Y)	99(Δ)
Torque constant $\pm 5\%$	K_t	[Nm/Arms]	2,86	1,64
Rated torque	T_N	[Nm]	1,6	1,6
Rated current	I_N	[Arms]	0,67	1,16
Efficiency	η	[%]	86,8	86,8
Maximum torque	T_s	[Nm]	3,2	3,2
Current maximum torque	I_s	[Arms]	1,3**	2,3**
Minimum switching frequency from inverter		[kHz]	4***	4***
Phase-to-phase resistance @20°C dc mode	R_{ff}	[Ω]	34,5	11,5
Phase-to-phase inductance @ 1 kHz	$L_{ff}/L_d/L_q$	[mH]	64,73/29,1/37,7	20,2/9,7/12,4
Moment of inertia	J	[kgm ²]	0,00018	
Motor weight		[kg]	3,6	
Operating temperature	θ_a	[°C]	-15 ÷ +40	
Degree of protection	IP		55	
Insulation class			F	
Overtemperature class			F/B	F/F
Service type			S1	
Standard thermal protection			PTC - 150°C	

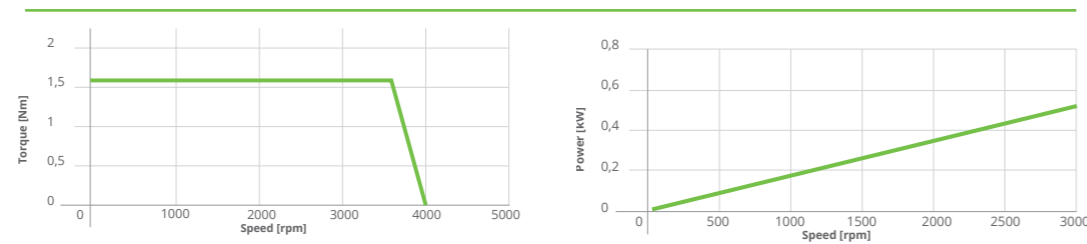
EOS 56b8 0,25kW
1500rpm 400VEOS 56b8 0,5kW
3000rpm 400V

*Preferential winding. **Values declared with current $i_d=0A$. ***Value to be entered in the inverter, any automatic frequency adaptation mode MUST be disabled.

IC 411



ZEPH 56b8

Inverter power supply 400 V

MOTOR IC411 (auto-ventilated)

0,09 kW

0,12 kW

Description	Symbol	Unit of measure	RATED SPEED (n_n)	
			1500 rpm*	3000 rpm*
ALUMINUM HOUSING				
Frequency	f	[Hz]	100	200
Number of Poles	p		8	8
Maximum no-load speed	n_{MAX}	[rpm]	2200	3600
Voltage constant (connected) $\pm 5\%$	K_e	[Vrms/krpm]	186 (Y)	107 (Δ)
Torque constant $\pm 5\%$	K_t	[Nm/Arms]	3,08	1,78
Rated torque	T_N	[Nm]	0,57	0,38
Rated current	I_N	[Arms]	0,2**	0,25**
Efficiency	η	[%]	76,8	78,7
Maximum torque	T_s	[Nm]	0,86	0,57
Current maximum torque	I_s	[Arms]	0,26**	0,3**
Minimum switching frequency from inverter		[kHz]	4***	4***
Phase-to-phase resistance @20°C dc mode	R_{ff}	[Ω]	244,1	81,2
Phase-to-phase inductance @ 1 kHz	$L_{ff}/L_d/L_q$	[mH]	281/163,3/180,7	88/49,7/58,4
Moment of inertia	J	[kgm ²]	65×10^{-6}	
Motor weight		[kg]	2,3	
Working temperature	θ_a	[°C]	-15 ÷ +40	
Degree of protection	IP		55	
Insulation class			F/B	
Service type			S1	
Standard thermal protection			PTC - 150°C	

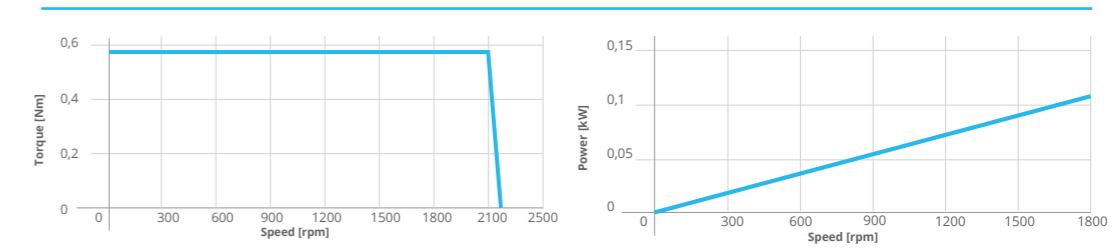
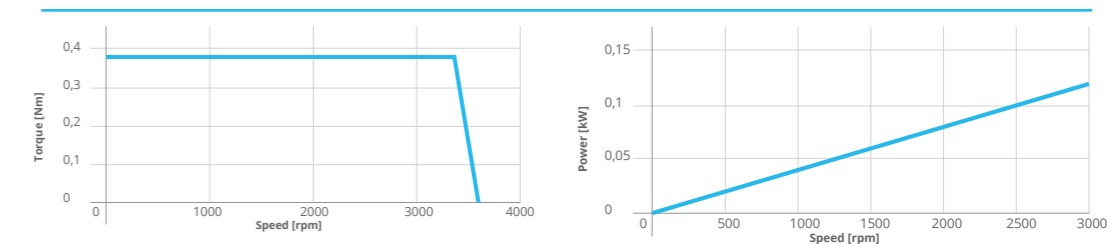
ZEPH 56b8 0,09kW
1500rpm 400VZEPH 56b8 0,12kW
3000rpm 400V

*Preferential winding. **Values declared with current $i_d=0A$. ***Value to be entered in the inverter, any automatic frequency adaptation mode MUST be disabled.

IC 411



EOS 63b8



ZEPH 63b8

Inverter power supply 400 V

MOTOR IC411 (auto-ventilated)

0,5 kW

1 kW

ALUMINUM HOUSING			RATED SPEED (n_n)	
Description	Symbol	Unit of measure	1500 rpm*	3000 rpm*
Frequency (N° Poles)	f	[Hz]	100	200
Number of Poles			8	8
Maximum no-load speed	n_{MAX}	[rpm]	2300	4000
Voltage constant (connected) $\pm 5\%$	Ke	[Vrms/krpm]	176 (Y)	102 (Δ)
Torque constant $\pm 5\%$	Kt	[Nm/Arms]	2,91	1,7
Rated torque	T_N	[Nm]	3,2	3,2
Rated current	I_N	[Arms]	1,25	2,1
Efficiency	η	[%]	84,5	87,4
Maximum torque	T_s	[Nm]	6,4	6,4
Current maximum torque	I_s	[Arms]	2,2**	3,8**
Minimum switching frequency from inverter		[kHz]	4***	4***
Phase-to-phase resistance @20°C dc mode	Rff	[Ω]	25,8	8,6
Phase-to-phase inductance @ 1 kHz	Lff/Ld/Lq	[mH]	56,6/27,5/32,4	17,2/8,6/10,7
Moment of inertia	J	[kgm ²]	0,00030	
Motor weight		[kg]	4,9	
Operating temperature	θ_a	[°C]	-15 ÷ +40	
Degree of protection	IP		55	
Insulation class			F	
Overtemperature class			F/B	F/F
Service type			S1	
Standard thermal protection			PTC - 150°C	

Inverter power supply 400 V

MOTOR IC411 (auto-ventilated)

0,18kW

0,25kW

ALUMINUM HOUSING			RATED SPEED (n_n)	
Description	Symbol	Unit of measure	1500 rpm*	3000 rpm*
Frequency	f	[Hz]	100	200
Number of Poles			8	8
Maximum no-load speed	n_{MAX}	[rpm]	2200	3600
Voltage constant (connected) $\pm 5\%$	Ke	[Vrms/krpm]	187 (Y)	108 (Δ)
Torque constant $\pm 5\%$	Kt	[Nm/Arms]	3,08	1,79
Rated torque	T_N	[Nm]	1,15	0,8
Rated current	I_N	[Arms]	0,4**	0,5**
Efficiency	η	[%]	78,8	80,7
Maximum torque	T_s	[Nm]	1,7	1,2
Current maximum torque	I_s	[Arms]	0,5**	0,63**
Minimum switching frequency from inverter		[kHz]	4***	4***
Phase-to-phase resistance @20°C dc mode	Rff	[Ω]	171,5	57,8
Phase-to-phase inductance @ 1 kHz	Lff/Ld/Lq	[mH]	268,1/153,6/178,2	89/44,8/53,5
Moment of inertia	J	[kgm ²]	100 x 10 ⁻⁶	
Motor weight		[kg]	3,2	
Working temperature	θ_a	[°C]	-15 ÷ +40	
Degree of protection	IP		55	
Insulation class			F	
Service type			S1	
Standard thermal protection			PTC - 150°C	

EOS 63b8 0,5kW 1500rpm 400V

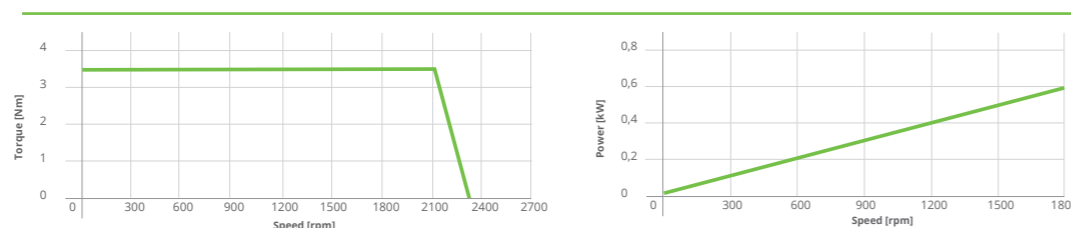

EOS 63b8 1kW 3000rpm 400 V

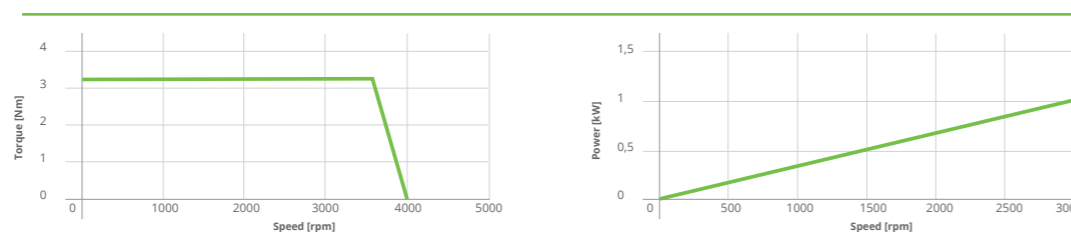

*Preferential winding. **Values declared with current $i_d=0A$. ***Value to be entered in the inverter, any automatic frequency adaptation mode MUST be disabled.

IC 411

ZEPH 63b8 0,18kW 1500rpm 400V

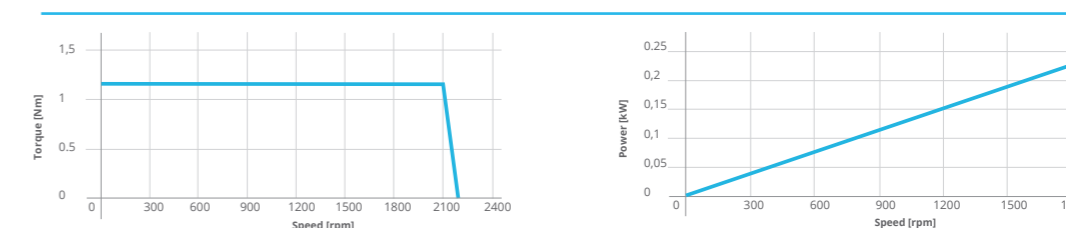

ZEPH 63b8 0,25kW 3000rpm 400V

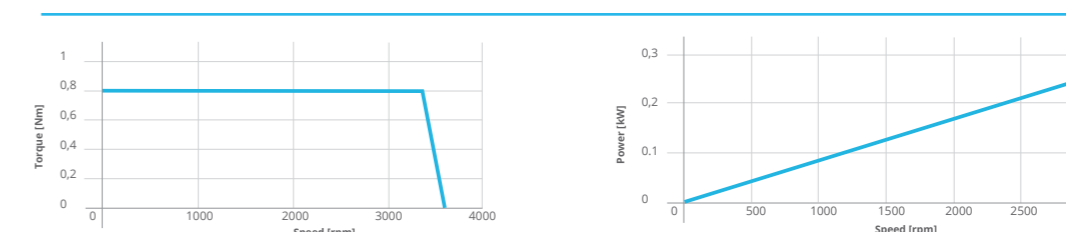

*Preferential winding. **Values declared with current $i_d=0A$. ***Value to be entered in the inverter, any automatic frequency adaptation mode MUST be disabled.

IC 411



EOS 71b6



ZEPH 71b6

Inverter power supply 400 V

MOTOR IC411 (auto-ventilated)

1,1 kW

2,2 kW

ALUMINUM HOUSING			RATED SPEED (n _v)	
Description	Symbol	Unit of measure	1500 rpm*	3000 rpm*
Frequency	f	[Hz]	75	150
Number of Poles			6	6
Maximum no-load speed	n _{MAX}	[rpm]	2300	3800
Voltage constant (connected) ±5%	Ke	[Vrms/krpm]	182 (Y)	105 (Δ)
Torque constant ±5%	Kt	[Nm/Arms]	3,0	1,7
Rated torque	T _N	[Nm]	7	7
Rated current	I _N	[Arms]	2,5	4,5
Efficiency	η	[%]	87,4	90,1
Maximum torque	T _s	[Nm]	14	14
Current maximum torque	I _s	[Arms]	4,8**	8,2**
Minimum switching frequency from inverter		[kHz]	4***	4***
Phase-to-phase resistance @20°C dc mode	R _{ff}	[Ω]	10,0	3,4
Phase-to-phase inductance @ 1 kHz	L _{ff} /L _d /L _q	[mH]	32,7/16,7/24,4	9,5/5,3/7,4
Moment of inertia	J	[kgm ²]	0,0012	
Motor weight		[kg]	6,6	
Operating temperature	θ _a	[°C]	-15 ÷ +40	
Degree of protection	IP		55	
Insulation class			F	
Overtemperature class			F/B	F/F
Service type			S1	
Standard thermal protection			PTC - 150°C	

Inverter power supply 400 V

MOTOR IC411 (auto-ventilated)

0,37 kW

0,55 kW

ALUMINUM HOUSING			RATED SPEED (n _v)	
Description	Symbol	Unit of measure	1500 rpm*	3000 rpm*
Frequency (N° Poles)	f	[Hz]	75 (6)	150 (6)
Number of Poles			6	6
Maximum no-load speed	n _{MAX}	[rpm]	2200	3600
Voltage constant (connected) ±5%	Ke	[Vrms/krpm]	193 (Y)	112 (Δ)
Torque constant ±5%	Kt	[Nm/Arms]	3,2	1,9
Rated torque	T _N	[Nm]	2,35	1,75
Rated current	I _N	[Arms]	0,62	1,1
Efficiency	η	[%]	81,9	82,2
Maximum torque	T _s	[Nm]	3,5	2,6
Current maximum torque	I _s	[Arms]	1,1**	1,4**
Minimum switching frequency from inverter		[kHz]	4***	4***
Phase-to-phase resistance @20°C dc mode	R _{ff}	[Ω]	105,6	35,1
Phase-to-phase inductance @ 1 kHz	L _{ff} /L _d /L _q	[mH]	217,6/109,8/160,0	72,5/34,1/50,2
Moment of inertia	J	[kgm ²]	0,00034	
Motor weight		[kg]	4,1	
Working temperature	θ _a	[°C]	-15 ÷ +40	
Degree of protection	IP		55	
Insulation class			F	
Service type			S1	
Standard thermal protection			PTC - 150°C	

EOS 71b6 1,1kW 1500rpm 400V

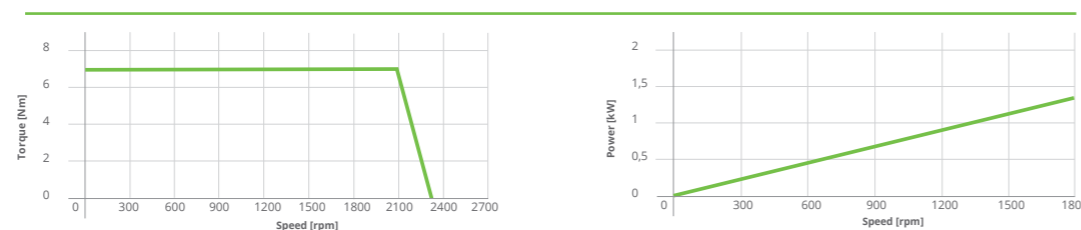

EOS 71b6 2,2kW 3000rpm 400V

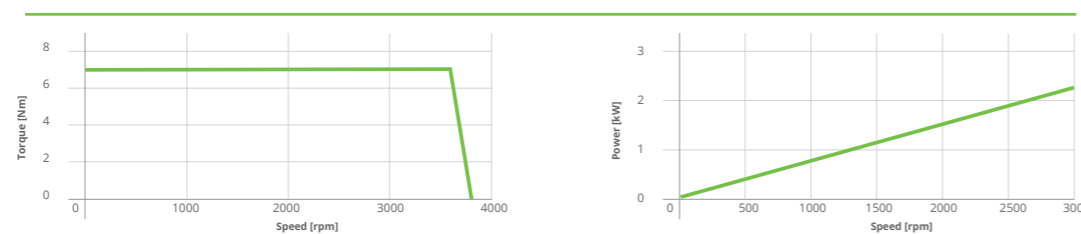

*Preferential winding. **Values declared with current id=0A. ***Value to be entered in the inverter, any automatic frequency adaptation mode MUST be disabled.

IC 411

ZEPH 71b6 0,37kW 1500rpm 400V

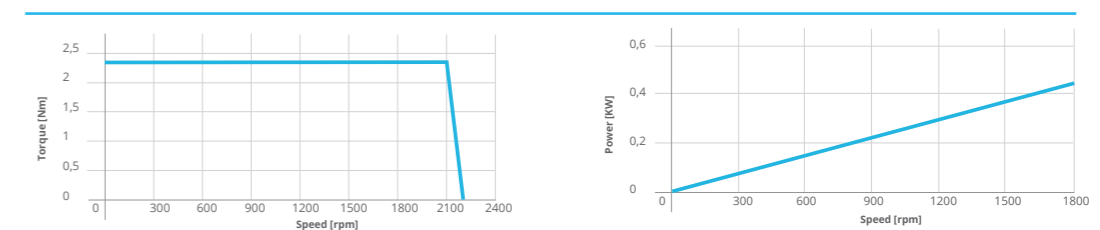

ZEPH 71b6 0,55kW 3000rpm 400V

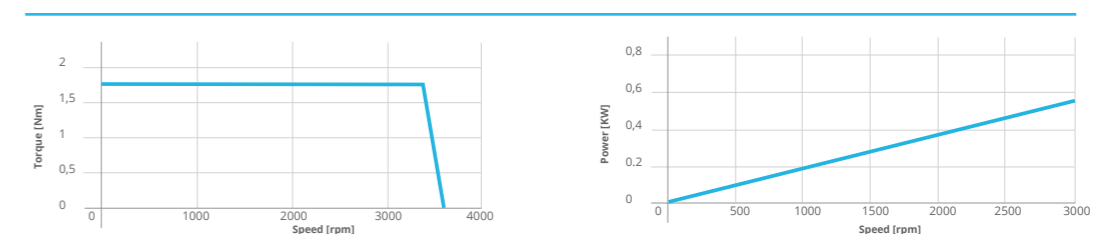

*Preferential winding. **Values declared with current id=0A. ***Value to be entered in the inverter, any automatic frequency adaptation mode MUST be disabled.

IC 411



EOS 80b6



ZEPH 80b6

Inverter power supply 400 V

MOTOR IC411 (auto-ventilated)

1,65 kW

3,3 kW

ALUMINUM HOUSING			RATED SPEED (n _n)	
Description	Symbol	Unit of measure	1500 rpm*	3000 rpm*
Frequency	f	[Hz]	75	150
Number of Poles			6	6
Maximum no-load speed	n _{MAX}	[rpm]	2300	4000
Voltage constant (connected) ±5%	Ke	[Vrms/krpm]	173 (Y)	100 (Δ)
Torque constant ±5%	Kt	[Nm/Arms]	2,86	1,65
Rated torque	T _N	[Nm]	10,5	10,5
Rated current	I _N	[Arms]	4,0	7,0
Efficiency	η	[%]	88,2	90,8
Maximum torque	T _s	[Nm]	21	21
Current maximum torque	I _s	[Arms]	7,2**	12,4**
Minimum switching frequency from inverter		[kHz]	4***	4***
Phase-to-phase resistance @20°C dc mode	R _{ff}	[Ω]	5,2	2,2
Phase-to-phase inductance @ 1 kHz	L _{ff} /L _d /L _q	[mH]	23,6/10,3/15,3	6,6/3,4/5,0
Moment of inertia	J	[kgm ²]	0,0015	
Motor weight		[kg]	9,2	
Operating temperature	θ _a	[°C]	-15 ÷ +40	
Degree of protection	IP		55	
Insulation class			F	
Overtemperature class			F/B	F/F
Service type			S1	
Standard thermal protection			PTC - 150°C	

Inverter power supply 400 V

MOTOR IC411 (auto-ventilated)

0,75 kW

1,1 kW

ALUMINUM HOUSING			RATED SPEED (n _n)	
Description	Symbol	Unit of measure	1500 rpm*	3000 rpm*
Frequency (N° Poles)	f	[Hz]	75	150
Number of Poles			6	6
Maximum no-load speed	n _{MAX}	[rpm]	2200	3600
Voltage constant (connected) ±5%	Ke	[Vrms/krpm]	190 (Y)	110 (Δ)
Torque constant ±5%	Kt	[Nm/Arms]	3,14	1,82
Rated torque	T _N	[Nm]	4,8	3,5
Rated current	I _N	[Arms]	1,7	2,3
Efficiency	η	[%]	85,8	85,9
Maximum torque	T _s	[Nm]	7,2	5,3
Current maximum torque	I _s	[Arms]	2,2**	2,8**
Minimum switching frequency from inverter		[kHz]	4***	4***
Phase-to-phase resistance @20°C dc mode	R _{ff}	[Ω]	26,7	8,9
Phase-to-phase inductance @ 1 kHz	L _{ff} /L _d /L _q	[mH]	92,6/46,1/57,9	31,0/14,8/18,5
Moment of inertia	J	[kgm ²]	0,00064	
Motor weight		[kg]	6,4	
Working temperature	θ _a	[°C]	-15 ÷ +40	
Degree of protection	IP		55	
Insulation class			F	
Service type			S1	
Standard thermal protection			PTC - 150°C	

EOS 80b6 1,65kW 1500rpm 400V

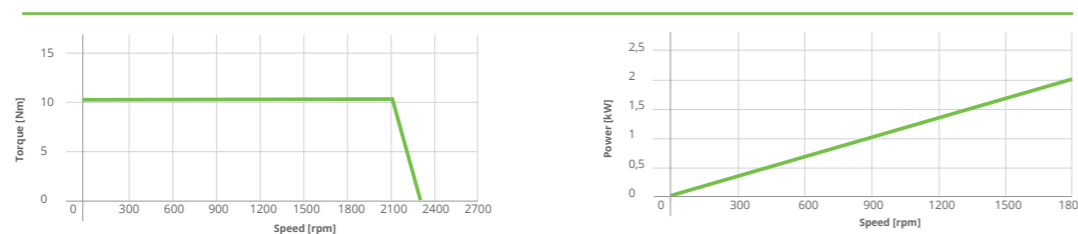

EOS 80b6 3,3kW 3000rpm 400V

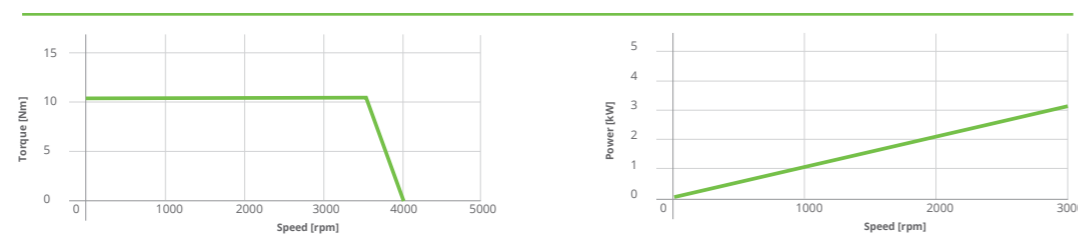

*Preferential winding. **Values declared with current id=0A. ***Value to be entered in the inverter, any automatic frequency adaptation mode MUST be disabled.

IC 411

ZEPH 80b6 0,75kW 1500rpm 400V

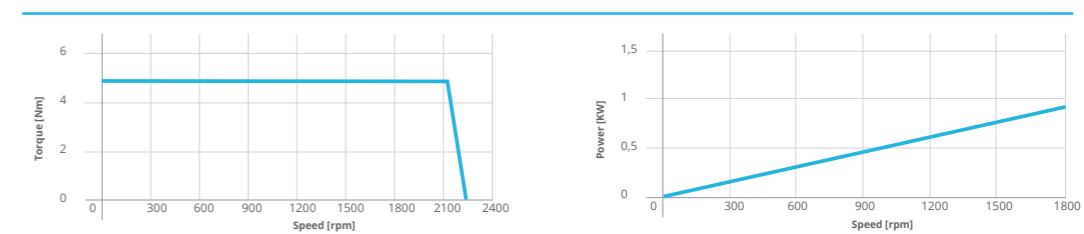

ZEPH 80b6 1,1kW 3000rpm 400V

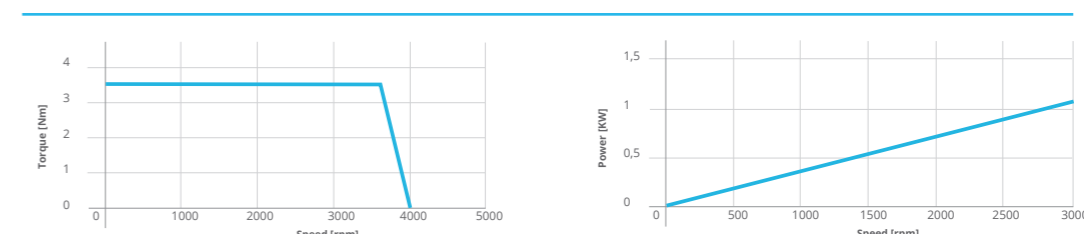

*Preferential winding. **Values declared with current id=0A. ***Value to be entered in the inverter, any automatic frequency adaptation mode MUST be disabled.

IC 411



EOS 90S6

Inverter power supply 400 V

MOTOR IC411 (auto-ventilated)

2,7 kW

5,4 kW

ALUMINUM HOUSING			RATED SPEED (n _v)	
Description	Symbol	Unit of measure	1500 rpm*	3000 rpm*
Frequency (N° Poles)	f	[Hz]	75	150
Number of Poles			6	6
Maximum speed	n _{MAX}	[rpm]	2300	4000
Voltage constant (connected) ±5%	Ke	[Vrms/krpm]	170 (Y)	99 (Δ)
Torque constant ±5%	Kt	[Nm/Arms]	2,81	1,64
Rated torque	T _N	[Nm]	17,2	17,2
Rated current	I _N	[Arms]	6,5	12,0
Efficiency	η	[%]	90,7	92,9
Maximum torque	T _s	[Nm]	34,4	34,4
Current maximum torque	I _s	[Arms]	11,8**	20,2**
Minimum switching frequency from inverter		[kHz]	4***	6***
Phase-to-phase resistance @20°C dc mode	R _{ff}	[Ω]	2,85	0,98
Phase-to-phase inductance @ 1 kHz	L _{ff} /L _d /L _q	[mH]	20,8/10,5/19,1	6,0/2,6/4,4
Moment of inertia	J	[kgm ²]	0,0029	
Motor weight		[kg]	14,4	
Operating temperature	θ _a	[°C]	-15 ÷ +40	
Degree of protection	IP		55	
Insulation class			F	
Overtemperature class			F/B	F/F
Service type			S1	
Standard thermal protection			PTC - 150°C	

* EOS 90S6 2,7kW
1500rpm 400V

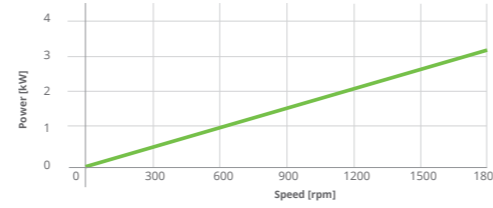
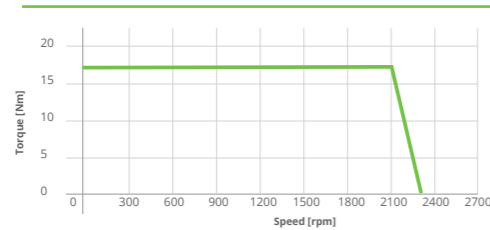

EOS 90S6 5,4kW
3000rpm 400V

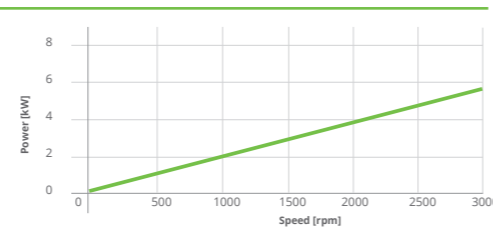
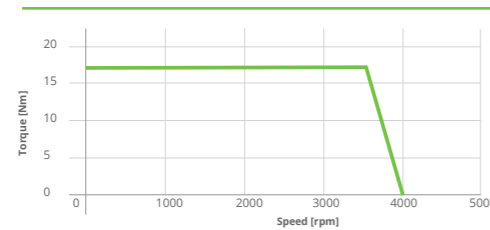

IC 411

*Preferential winding. **Values declared with current id=0A. ***Value to be entered in the inverter, any automatic frequency adaptation mode MUST be disabled.



ZEPH 90S6

Inverter power supply 400 V

MOTOR IC411 (auto-ventilated)

1,1 kW

1,5 kW

ALUMINUM HOUSING			RATED SPEED (n _v)	
Description	Symbol	Unit of measure	1500 rpm*	3000 rpm*
Frequency	f	[Hz]	75	150
Number of Poles			6	6
Maximum no-load speed	n _{MAX}	[rpm]	2200	3700
Voltage constant (connected) ±5%	Ke	[Vrms/krpm]	186 (Y)	107 (Δ)
Torque constant ±5%	Kt	[Nm/Arms]	3,1	1,77
Rated torque	T _N	[Nm]	7	4,8
Rated current	I _N	[Arms]	2,6	3,1
Efficiency	η	[%]	87,3	87,8
Maximum torque	T _s	[Nm]	10,5	7,2
Current maximum torque	I _s	[Arms]	3,2**	3,8**
Minimum switching frequency from inverter		[kHz]	4***	4***
Phase-to-phase resistance @20°C dc mode	R _{ff}	[Ω]	19,5	6,5
Phase-to-phase inductance @ 1 kHz	L _{ff} /L _d /L _q	[mH]	87,9/42,9/56,7	29,2/13,65/18,9
Moment of inertia	J	[kgm ²]	0,001	
Motor weight		[kg]	8,6	
Working temperature	θ _a	[°C]	-15 ÷ +40	
Degree of protection	IP		55	
Insulation class			F	
Service type			S1	
Standard thermal protection			PTC - 150°C	

ZEPH 90S6 1,1kW
1500rpm 400V

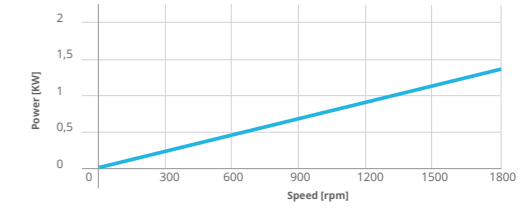
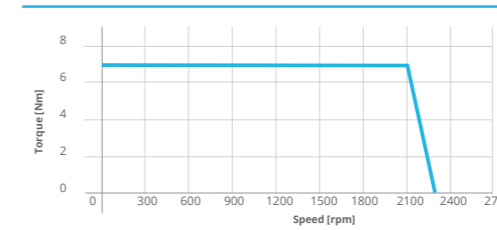

ZEPH 90S6 1,5kW
3000rpm 400V

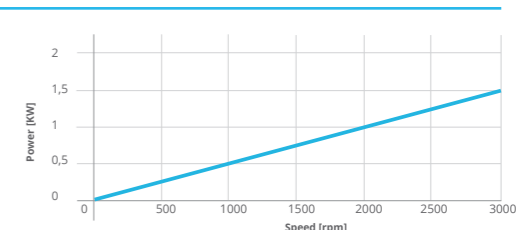
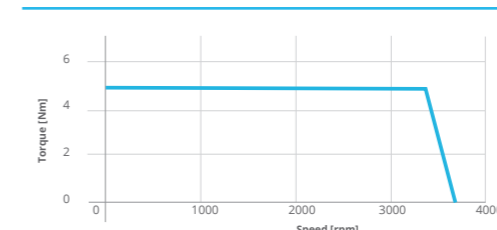

IC 411

*Preferential winding. **Values declared with current id=0A. ***Value to be entered in the inverter, any automatic frequency adaptation mode MUST be disabled.



EOS 90La6



ZEPH 90L6

Inverter power supply 400 V

MOTOR IC411 (auto-ventilated)

3,3 kW

6,6 kW

ALUMINUM HOUSING			RATED SPEED (n_n)	
Description	Symbol	Unit of measure	1500 rpm*	3000 rpm*
Frequency	f	[Hz]	75	150
Number of Poles			6	6
Maximum no-load speed	n_{MAX}	[rpm]	2300	4000
Voltage constant (connected) $\pm 5\%$	K_e	[Vrms/krpm]	171 (Y)	100 (Δ)
Torque constant $\pm 5\%$	K_t	[Nm/Arms]	2,8	1,65
Rated torque	T_N	[Nm]	21	21
Rated current	I_N	[Arms]	8,1	14,5
Efficiency	η	[%]	91	93,8
Maximum torque	T_s	[Nm]	42	42
Current maximum torque	I_s	[Arms]	14**	24,2**
Minimum switching frequency from inverter		[kHz]	4***	4***
Phase-to-phase resistance @20°C dc mode	Rff	[Ω]	1,77	0,62
Phase-to-phase inductance @ 1 kHz	Lff/Ld/Lq	[mH]	10,7/6,2/9,1	3,77/1,8/2,8
Moment of inertia	J	[kgm ²]	0,0035	
Motor weight		[kg]	19	
Operating temperature	θ_a	[°C]	-15 \div +40	
Degree of protection	IP		55	
Insulation class			F	
Overtemperature class			F/B	F/F
Service type			S1	
Standard thermal protection			PTC - 150°C	

Inverter power supply 400 V

MOTOR IC411 (auto-ventilated)

1,5 kW

2,2 kW

ALUMINUM HOUSING			RATED SPEED (n_n)	
Description	Symbol	Unit of measure	1500 rpm*	3000 rpm*
Frequency	f	[Hz]	75	150
Number of Poles			6	6
Maximum no-load speed	n_{MAX}	[rpm]	2200	3600
Voltage constant (connected) $\pm 5\%$	K_e	[Vrms/krpm]	192 (Y)	111 (Δ)
Torque constant $\pm 5\%$	K_t	[Nm/Arms]	3,17	1,84
Rated torque	T_N	[Nm]	9,55	7
Rated current	I_N	[Arms]	3,3	4,5
Efficiency	η	[%]	89,3	91,2
Maximum torque	T_s	[Nm]	14,3	10,5
Current maximum torque	I_s	[Arms]	4,3**	5,5**
Minimum switching frequency from inverter		[kHz]	4***	4***
Phase-to-phase resistance @20°C dc mode	Rff	[Ω]	6,8	2,3
Phase-to-phase inductance @ 1 kHz	Lff/Ld/Lq	[mH]	38,6/17,8/26,3	12,8/5,5/8,2
Moment of inertia	J	[kgm ²]	0,0016	
Motor weight		[kg]	10,3	
Working temperature	θ_a	[°C]	-15 \div +40	
Degree of protection	IP		55	
Insulation class			F	
Service type			S1	
Standard thermal protection			PTC - 150°C	

EOS 90La6 3,3kW 1500rpm 400V

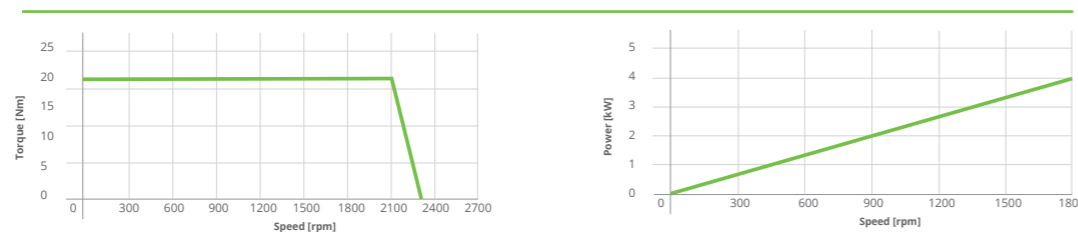

EOS 90La6 6,6kW 3000rpm 400V

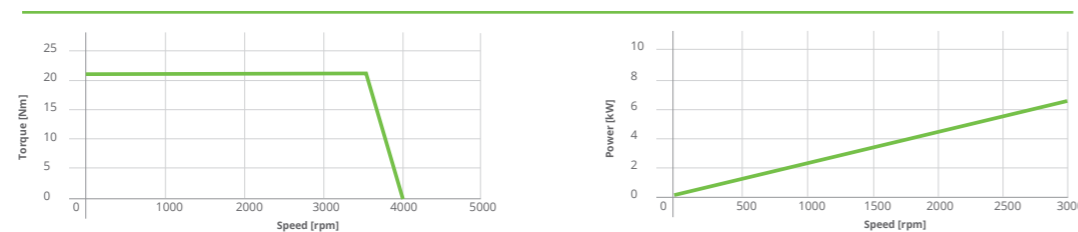

ZEPH 90L6 1,5kW 1500rpm 400V

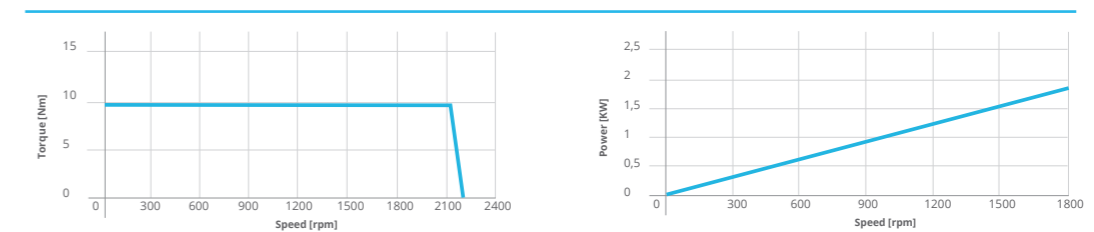

ZEPH 90L6 2,2kW 3000rpm 400V

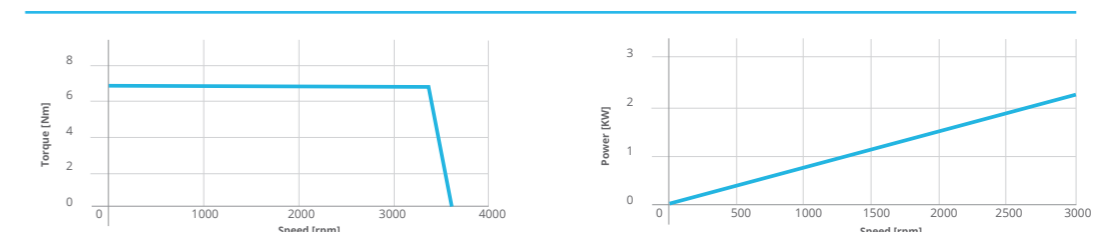

*Preferential winding. **Values declared with current $i_d=0A$. ***Value to be entered in the inverter, any automatic frequency adaptation mode MUST be disabled.

IC 411

*Preferential winding. **Values declared with current $i_d=0A$. ***Value to be entered in the inverter, any automatic frequency adaptation mode MUST be disabled.

IC 411



EOS 100La6



ZEPH 100L6

Inverter power supply 400 V

MOTOR IC411 (auto-ventilated)

4 kW

8 kW

ALUMINUM HOUSING			RATED SPEED (n _v)	
Description	Symbol	Unit of measure	1500 rpm*	3000 rpm*
Frequency	f	[Hz]	75	150
Number of Poles			6	6
Maximum no-load speed	n _{MAX}	[rpm]	2300	4000
Voltage constant (connected) ±5%	Ke	[Vrms/krpm]	170 (Y)	98 (Δ)
Torque constant ±5%	Kt	[Nm/Arms]	2,81	1,62
Rated torque	T _N	[Nm]	25,7	25,7
Rated current	I _N	[Arms]	9,9	18,4
Efficiency	η	[%]	91,6	93,1
Maximum torque	T _s	[Nm]	51	51
Current maximum torque	I _s	[Arms]	17,6**	30,2**
Minimum switching frequency from inverter		[kHz]	4***	6***
Phase-to-phase resistance @20°C dc mode	R _{ff}	[Ω]	1,5	0,5
Phase-to-phase inductance @ 1 kHz	L _{ff/Ld/Lq}	[mH]	11,1/5,5/7,1	3,34/1,6/2,2
Moment of inertia	J	[kgm ²]	0,0069	
Motor weight		[kg]	22	
Operating temperature	θ _a	[°C]	-15 ÷ +40	
Degree of protection	IP		55	
Insulation class			F	
Overtemperature class			F/B	F/F
Service type			S1	
Standard thermal protection			PTC - 150°C	

Inverter power supply 400 V

MOTOR IC411 (auto-ventilated)

2,2 kW

3 kW

ALUMINUM HOUSING			RATED SPEED (n _v)	
Description	Symbol	Unit of measure	1500 rpm*	3000 rpm*
Frequency	f	[Hz]	75	150
Number of Poles			6	6
Maximum no-load speed	n _{MAX}	[rpm]	2200	3500
Voltage constant (connected) ±5%	Ke	[Vrms/krpm]	188 (Y)	109 (Δ)
Torque constant ±5%	Kt	[Nm/Arms]	3,11	1,80
Rated torque	T _N	[Nm]	14	9,55
Rated current	I _N	[Arms]	4,9	6,2
Efficiency	η	[%]	89,6	90
Maximum torque	T _s	[Nm]	21	14,3
Current maximum torque	I _s	[Arms]	6,4**	7,5**
Minimum switching frequency from inverter		[kHz]	4***	4***
Phase-to-phase resistance @20°C dc mode	R _{ff}	[Ω]	4,56	1,53
Phase-to-phase inductance @ 1 kHz	L _{ff/Ld/Lq}	[mH]	27,2/15,2/19,5	9,1/4,6/5,7
Moment of inertia	J	[kgm ²]	0,0036	
Motor weight		[kg]	15,2	
Working temperature	θ _a	[°C]	-15 ÷ +40	
Degree of protection	IP		55	
Insulation class			F	
Service type			S1	
Standard thermal protection			PTC - 150°C	

EOS 100La6 4kW 1500rpm 400V

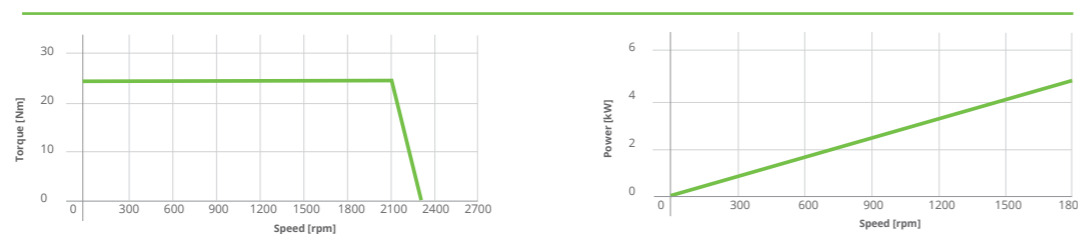

EOS 100La6 8kW 3000rpm 400V

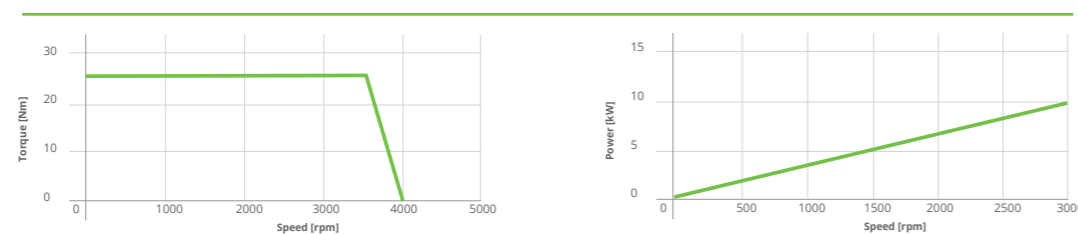

*Preferential winding. **Values declared with current id=0A. ***Value to be entered in the inverter, any automatic frequency adaptation mode MUST be disabled.

IC 411

ZEPH 100L6 2,2kW 1500rpm 400V

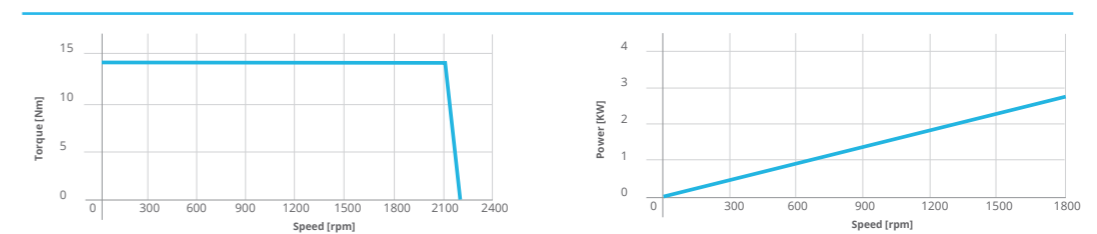

ZEPH 100L6 3kW 3000rpm 400V

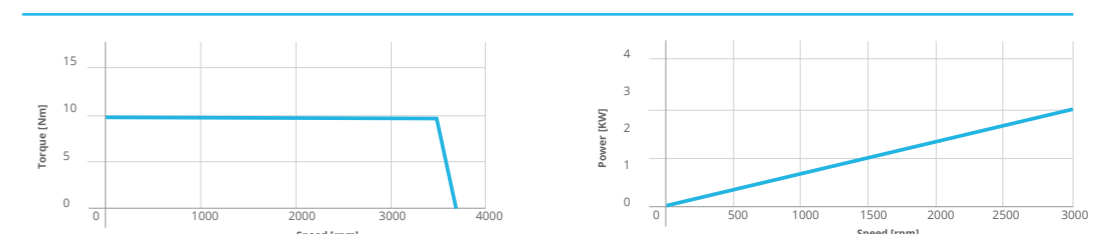

*Preferential winding. **Values declared with current id=0A. ***Value to be entered in the inverter, any automatic frequency adaptation mode MUST be disabled.

IC 411



EOS 112Ma6



ZEPH 112M6

Inverter power supply 400 V

MOTOR IC411 (auto-ventilated)

7,5 kW

15 kW

ALUMINUM HOUSING			RATED SPEED (n_n)	
Description	Symbol	Unit of measure	1500 rpm*	3000 rpm*
Frequency	f	[Hz]	75	150
Number of Poles			6	6
Maximum no-load speed	n_{MAX}	[rpm]	2200	3800
Voltage constant (connected) $\pm 5\%$	K_e	[Vrms/krpm]	180 (Y)	104 (Δ)
Torque constant $\pm 5\%$	K_t	[Nm/Arms]	3	1,72
Rated torque	T_N	[Nm]	47,7	47,7
Rated current	I_N	[Arms]	17,5	32,0
Efficiency	η	[%]	92,9	94
Maximum torque	T_s	[Nm]	95,4	95,4
Current maximum torque	I_s	[Arms]	31,8**	54,8**
Minimum switching frequency from inverter		[kHz]	8***	8***
Phase-to-phase resistance @20°C dc mode	R_{ff}	[Ω]	0,90	0,34
Phase-to-phase inductance @ 1 kHz	$L_{ff}/L_d/L_q$	[mH]	6,2/4,4/5,7	2,63/1,1/1,9
Moment of inertia	J	[kgm ²]		0,014
Motor weight		[kg]		29
Operating temperature	θ_a	[°C]		-15 ÷ +40
Degree of protection	IP			55
Insulation class				F
Overtemperature class			F/B	F/F
Service type				S1
Standard thermal protection				PTC - 150°C

Inverter power supply 400 V

MOTOR IC411 (auto-ventilated)

4 kW

5,5 kW

ALUMINUM HOUSING			RATED SPEED (n_n)	
Description	Symbol	Unit of measure	1500 rpm*	3000 rpm*
Frequency	f	[Hz]	75	150
Number of Poles			6	6
Maximum no-load speed	n_{MAX}	[rpm]	2200	3600
Voltage constant (connected) $\pm 5\%$	K_e	[Vrms/krpm]	189 (Y)	111 (Δ)
Torque constant $\pm 5\%$	K_t	[Nm/Arms]	3,13	1,84
Rated torque	T_N	[Nm]	25,5	17,5
Rated current	I_N	[Arms]	8,9	11,1
Efficiency	η	[%]	91,2	91,8
Maximum torque	T_s	[Nm]	38,3	26,3
Current maximum torque	I_s	[Arms]	11,6**	13,8**
Minimum switching frequency from inverter		[kHz]	4***	4***
Phase-to-phase resistance @20°C dc mode	R_{ff}	[Ω]	2,84	0,95
Phase-to-phase inductance @ 1 kHz	$L_{ff}/L_d/L_q$	[mH]	26,8/11,5/14,7	8,9/3,3/4,8
Moment of inertia	J	[kgm ²]		0,007
Motor weight		[kg]		19,6
Working temperature	θ_a	[°C]		-15 ÷ +40
Degree of protection	IP			55
Insulation class				F
Service type				S1
Standard thermal protection				PTC - 150°C

EOS 112Ma6 7,5kW 1500rpm 400V

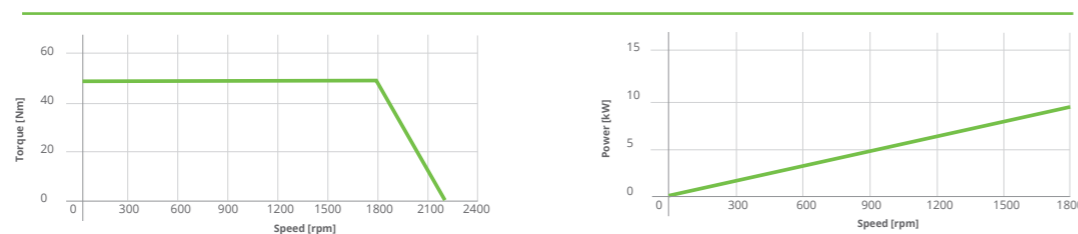

EOS 112Ma6 15kW 3000rpm 400V

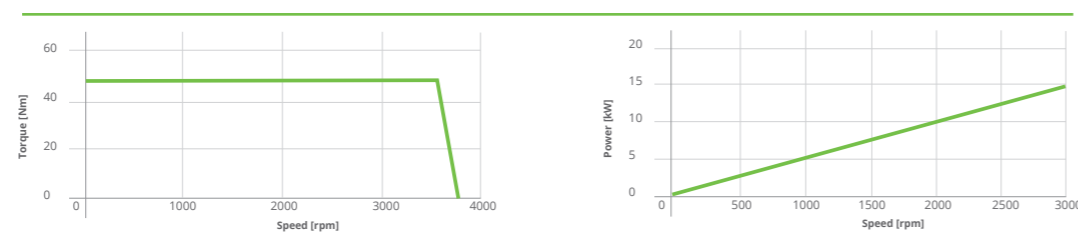

*Preferential winding. **Values declared with current $i_d=0A$. ***Value to be entered in the inverter, any automatic frequency adaptation mode MUST be disabled.

IC 411

ZEPH 112M6 4kW 1500rpm 400V

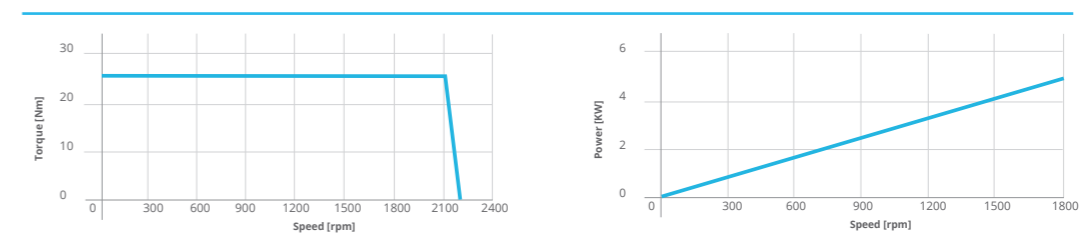

ZEPH 112M6 5,5kW 3000rpm 400V

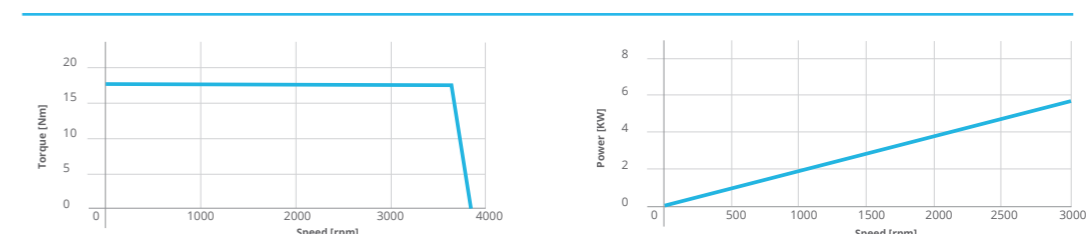

*Preferential winding. **Values declared with current $i_d=0A$. ***Value to be entered in the inverter, any automatic frequency adaptation mode MUST be disabled.

IC 411



EOS 132Mb6



ZEPH 132M6

Inverter power supply 400 V

MOTOR IC411 (auto-ventilated)

12 kW

24 kW

ALUMINUM HOUSING			RATED SPEED (n _v)	
Description	Symbol	Unit of measure	1500 rpm*	3000 rpm*
Frequency	f	[Hz]	75	150
Number of Poles			6	6
Maximum no-load speed	n _{MAX}	[rpm]	2300	4000
Voltage constant (connected) ±5%	Ke	[Vrms/krpm]	167 (Y)	91 (Δ)
Torque constant ±5%	Kt	[Nm/Arms]	2,76	1,51
Rated torque	T _N	[Nm]	76,4	76,4
Rated current	I _N	[Arms]	31,8	59,3
Efficiency	η	[%]	94,4	95,4
Maximum torque	T _s	[Nm]	152,8	152,8
Current maximum torque	I _s	[Arms]	53**	111**
Minimum switching frequency from inverter		[kHz]	6***	4***
Phase-to-phase resistance @20°C dc mode	R _{ff}	[Ω]	0,29	0,12
Phase-to-phase inductance @ 1 kHz	L _{ff} /L _d /L _q	[mH]	7,7/6,0/9,3	2,4/1,8/2,9
Moment of inertia of the rotor	J	[kgm ²]	0,0449	
Motor weight		[kg]	55	
Working temperature	θ _a	[°C]	-15 ÷ +40	
Degree of protection	IP		55	
Insulation class			F	
Overtemperature class			F/B	F/F
Service type			S1	
Standard thermal protection			PTC - 150°C	

Inverter power supply 400 V

MOTOR IC411 (auto-ventilated)

7,5 kW

11 kW

ALUMINUM HOUSING			RATED SPEED (n _v)	
Description	Symbol	Unit of measure	1500 rpm*	3000 rpm*
Frequency	f	[Hz]	75	150
Number of Poles			6	6
Maximum no-load speed	n _{MAX}	[rpm]	2200	3600
Voltage constant (connected) ±5%	Ke	[Vrms/krpm]	192 (Y)	111 (Δ)
Torque constant ±5%	Kt	[Nm/Arms]	3,18	1,84
Rated torque	T _N	[Nm]	47,8	35
Rated current	I _N	[Arms]	18,4	24,1
Efficiency	η	[%]	92,9	93,3
Maximum torque	T _s	[Nm]	71,7	52,5
Current maximum torque	I _s	[Arms]	21,7**	27,5**
Minimum switching frequency from inverter		[kHz]	4***	4***
Phase-to-phase resistance @20°C dc mode	R _{ff}	[Ω]	0,95	0,37
Phase-to-phase inductance @ 1 kHz	L _{ff} /L _d /L _q	[mH]	8,67/5,4/7,0	2,88/1,3/2,1
Moment of inertia of the rotor	J	[kgm ²]	0,0225	
Motor weight		[kg]	35,5	
Working temperature	θ _a	[°C]	-15 ÷ +40	
Degree of protection	IP		55	
Insulation class			F	
Service type			S1	
Standard thermal protection			PTC - 150°C	

EOS 132Mb6 12kW 1500rpm 400V

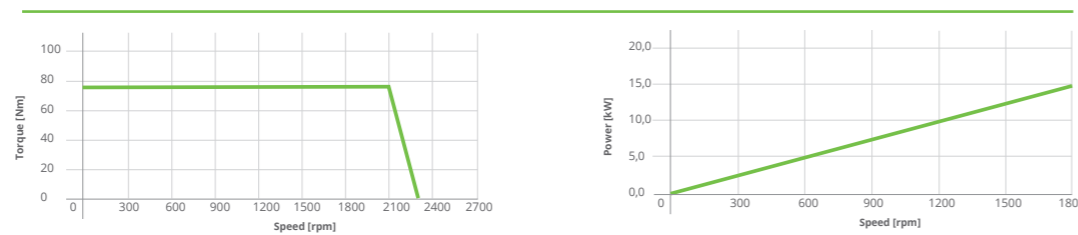

EOS 132Mb6 24kW 3000rpm 400V

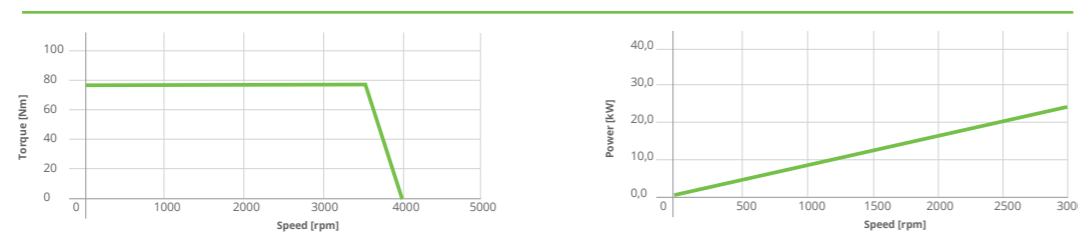

ZEPH 132M6 7,5kW 1500rpm 400V

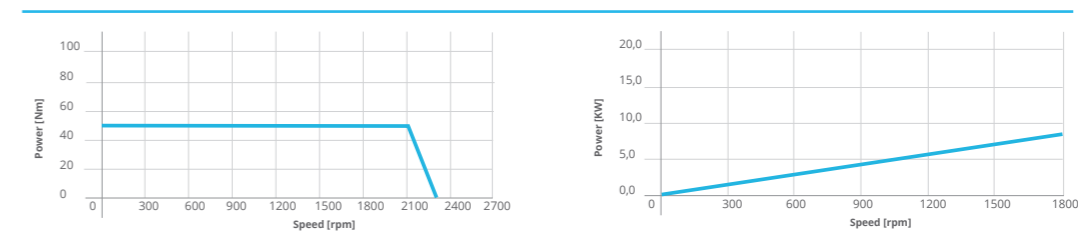

ZEPH 132M6 11kW 3000rpm 400V

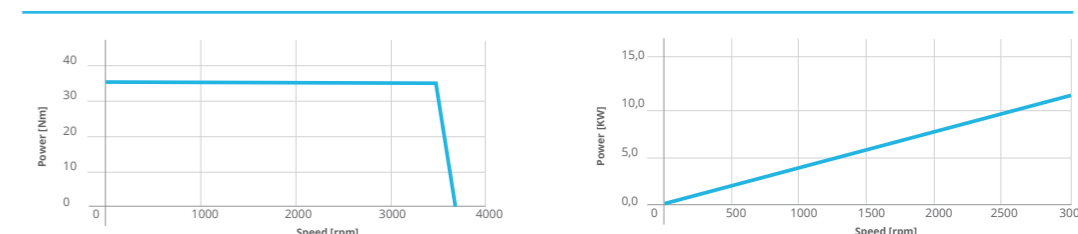

*Preferential winding. **Values declared with current id=0A. ***Value to be entered in the inverter, any automatic frequency adaptation mode MUST be disabled.

IC 411

*Preferential winding. **Values declared with current id=0A. ***Value to be entered in the inverter, any automatic frequency adaptation mode MUST be disabled.

IC 411



EOS 160Lb6



ZEPH 160L6

Inverter power supply 400 V

MOTOR IC411 (auto-ventilated)

20,4 kW 40,8 kW

ALUMINUM HOUSING			RATED SPEED (n _v)	
Description	Symbol	Unit of measure	1500 rpm*	3000 rpm*
Frequency	f	[Hz]	75	150
Number of Poles			6	6
Maximum speed	n _{MAX}	[rpm]	2300	4100
Voltage constant (connected) ±5%	Ke	[Vrms/krpm]	172 (Y)	99
Torque constant ±5%	Kt	[Nm/Arms]	2,85	1,7
Rated torque	T _N	[Nm]	130	130
Rated current	I _N	[Arms]	51,5	84,2
Efficiency	η	[%]	95,5	95,6
Maximum torque	T _s	[Nm]	260	260
Current maximum torque	I _s	[Arms]	86,6**	152,9**
Minimum switching frequency from inverter		[kHz]	6***	0,11
Phase-to-phase resistance @20°C dc mode	R _{ff}	[Ω]	0,22	0,10
Phase-to-phase inductance @ 1 kHz	L _{ff} /L _d /L _q	[mH]	6/4,7/7,3	1,85/1,5/2,2
Moment of inertia of the rotor	J	[kgm ²]	0,1160	
Motor weight		[kg]	98	
Operating temperature	θ _a	[°C]	-15 ÷ +40	
Degree of protection	IP		55	
Insulation class			F	
Overtemperature class			F/B	F/F
Service type			S1	
Standard thermal protection			PTC - 150°C	

Inverter power supply 400 V

MOTOR IC411 (auto-ventilated)

11 kW 18,5 kW

ALUMINUM HOUSING			RATED SPEED (n _v)	
Description	Symbol	Unit of measure	1500 rpm*	3000 rpm*
Frequency	f	[Hz]	75	150
Number of Poles			6	6
Maximum speed	n _{MAX}	[rpm]	2200	3600
Voltage constant (connected) ±5%	Ke	[Vrms/krpm]	190 (Y)	111 (Δ)
Torque constant ±5%	Kt	[Nm/Arms]	3,14	1,84
Rated torque	T _N	[Nm]	70	58,9
Rated current	I _N	[Arms]	26,5	38,2
Efficiency	η	[%]	93,3	93,5
Maximum torque	T _s	[Nm]	105	88,4
Current maximum torque	I _s	[Arms]	32,4**	47,3**
Minimum switching frequency from inverter		[kHz]	4***	4***
Phase-to-phase resistance @20°C dc mode	R _{ff}	[Ω]	0,56	0,18
Phase-to-phase inductance @ 1 kHz	L _{ff} /L _d /L _q	[mH]	6,42/4,0/5,2	2,21/0,97/1,6
Moment of inertia of the rotor	J	[kgm ²]	0,058	
Motor weight		[kg]	59,8	
Working temperature	θ _a	[°C]	-15 ÷ +40	
Degree of protection	IP		55	
Insulation class			F	
Service type			S1	
Standard thermal protection			PTC - 150°C	

EOS 160La6 20,4kW 1500rpm 400V

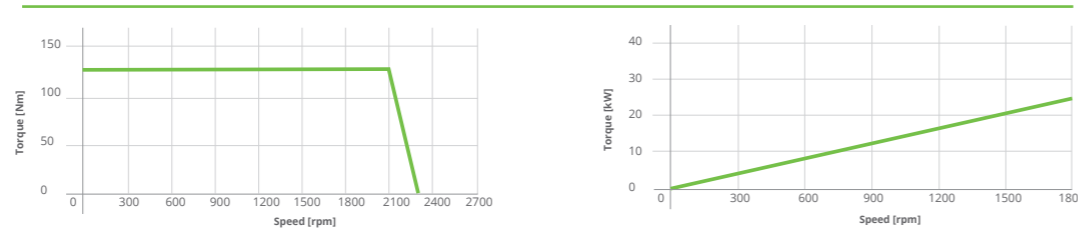

EOS 160La6 40,8kW 3000rpm 400V

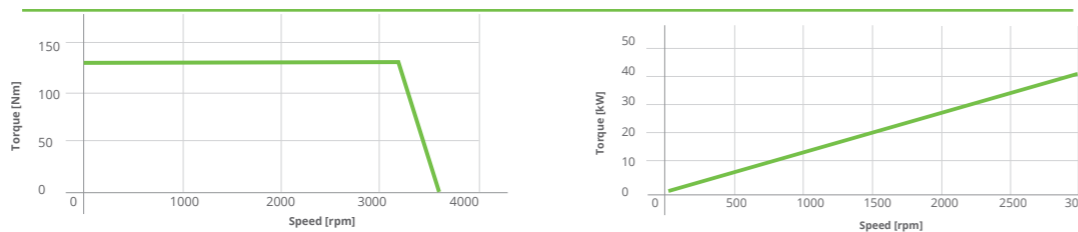

*Preferential winding. **Values declared with current id=0A. ***Value to be entered in the inverter, any automatic frequency adaptation mode MUST be disabled.

IC 411

ZEPH 160M6 11kW 1500rpm 400V

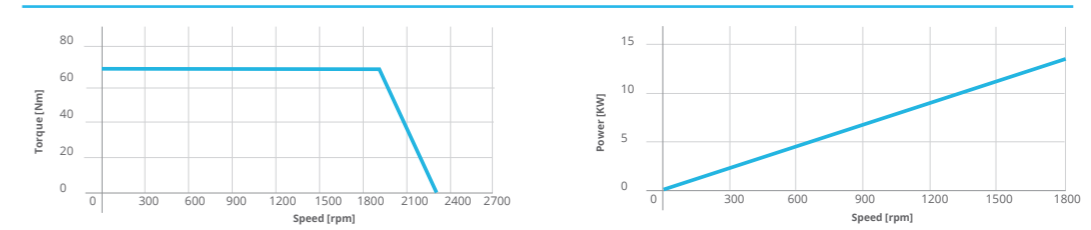

ZEPH 160L6 18,5kW 3000rpm 400V

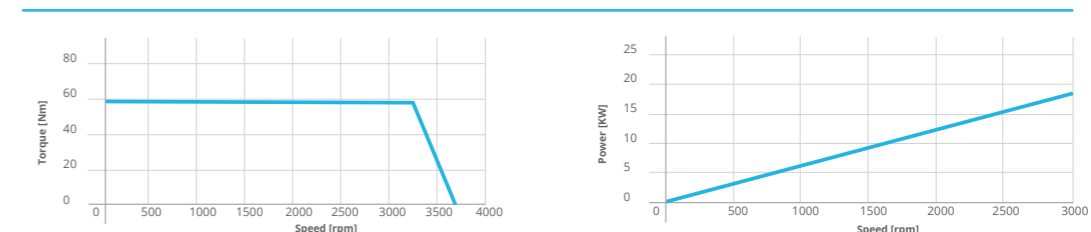

*Preferential winding. **Values declared with current id=0A. ***Value to be entered in the inverter, any automatic frequency adaptation mode MUST be disabled.

IC 411



EOS 180La



EOS
200La8

EOS
200Lb8

Inverter power supply 400 Vac

MOTOR IC411 (auto-ventilated)

37 kW

HOUSING IN CAST IRON			RATED SPEED (n_N)	
Description	Symbol	Unit of measure	1500 rpm	
Frequency	f	[Hz]	100	
Number of Poles			8	
Maximum speed	n_{MAX}	[rpm]	1650	
Voltage constant (connected) $\pm 5\%$	K_e	[Vrms/krpm]	232	
Torque constant $\pm 5\%$	K_t	[Nm/Arms]	3,8	
Rated torque	M_N	[Nm]	235,6	
Rated current	I_N	[Arms]	69	
Efficiency	η	[%]	95,2	
Maximum torque	Mmax	[Nm]	589	
Current maximum torque	Imax	[Arms]	173	
Minimum switching frequency from inverter		[kHz]	4***	
Phase-to-phase resistance @20°C dc mode	Rpp	[mΩ]	64,36	
Phase-to-phase inductance Lq	Lq	[mH]	3,543	
Phase-to-phase inductance Ld	Ld	[mH]	1,206	
Moment of inertia of the rotor	J	[kgm ²]	0,26	
Motor weight		[kg]	209	
Working temperature		[°C]	-15 ÷ +40	
Degree of protection			55	
Insulation class			F	
Service type			S1	
Standard thermal protection			PTC - 150°C	

Inverter power supply 400 Vac

MOTOR IC411 (auto-ventilated)

30 kW

45 kW

HOUSING IN CAST IRON			RATED SPEED (n_N)	
Description	Symbol	Unit of measure	1000 rpm	1500 rpm
Frequency	f	[Hz]	66,7	100
Number of Poles			8	8
Maximum speed	n_{MAX}	[rpm]	1100	1650
Voltage constant (connected) $\pm 5\%$	K_e	[Vrms/krpm]	366	228
Torque constant $\pm 5\%$	K_t	[Nm/Arms]	5,52	3,76
Rated torque	M_N	[Nm]	286,5	286,5
Rated current	I_N	[Arms]	57	78
Efficiency	η	[%]	94,2	95,4
Maximum torque	Mmax	[Nm]	716	716
Current maximum torque	Imax	[Arms]	143	202
Minimum switching frequency from inverter		[kHz]	4***	4***
Phase-to-phase resistance @20°C dc mode	Rpp	[mΩ]	0,1145	56,61
Phase-to-phase inductance Lq	Lq	[mH]	6,377	2,43
Phase-to-phase inductance Ld	Ld	[mH]	2,185	0,92
Moment of inertia of the rotor	J	[kgm ²]	0,21	0,51
Motor weight		[kg]	219	325
Working temperature		[°C]	-15 ÷ +40	
Degree of protection			55	
Insulation class			F	
Service type			S1	
Standard thermal protection			PTC - 150°C	

EOS 180La8 37kW 1500rpm 400V

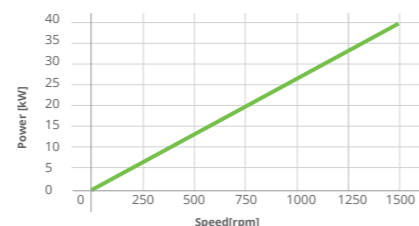
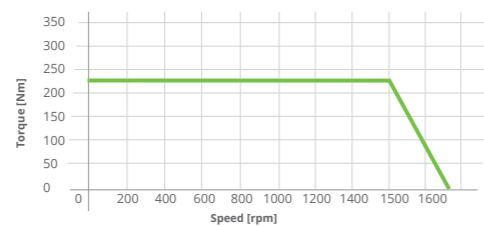

EOS 200La8 30kW 1000rpm 400V

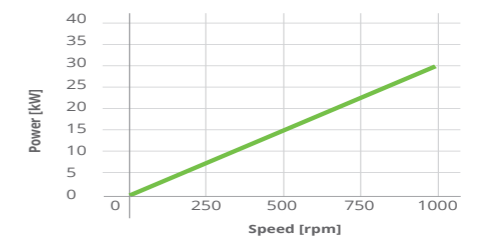
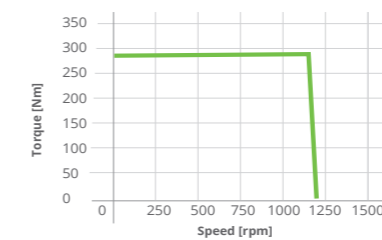

EOS 200Lb8 45kW 1500rpm 400V

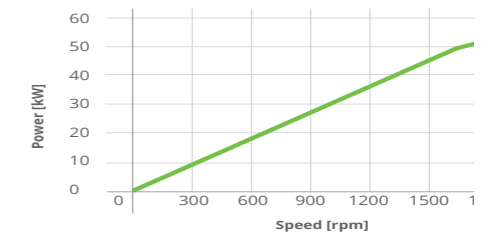
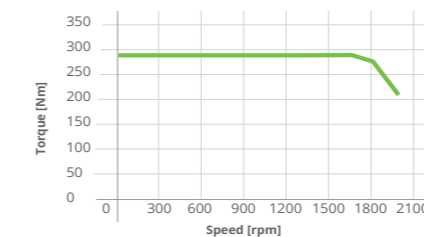

***Value to be entered in the inverter, any automatic frequency adaptation mode MUST be disabled.

IC 411

***Value to be entered in the inverter, any automatic frequency adaptation mode MUST be disabled.

IC 411



EOS 225Sa8 EOS 225Mb8 EOS 225Sa8 EOS 225Sa8 EOS 225Sb8

Inverter power supply 400 Vac

MOTOR IC411 (auto-ventilated) 37 kW 45 kW 55 kW 55 kW 75 kW

Description	Symbol	Unit of measure	RATED SPEED (n_N)				
			1000 rpm	1500 rpm	3000 rpm	3000 rpm	3000 rpm
Frequency	f	[Hz]	66,7	66,7	100	200	200
Number of Poles			8	8	8	8	8
Maximum speed	n_{MAX}	[rpm]	1100	1100	1650	3300	3300
Voltage constant (connected) $\pm 5\%$	Ke	[Vrms/krpm]	343	342,1	230	114	114
Torque constant $\pm 5\%$	Kt	[Nm/Arms]	5,65	5,64	3,74	1,88	1,88
Rated torque	M_N	[Nm]	353,4	430	350	175	239
Rated current	I_N	[Arms]	64	77	96	95,5	131
Efficiency	η	[%]	94,5	94,8	95,7	95,3	95,6
Maximum torque	Mmax	[Nm]	883	1074	875	438	596
Current maximum torque	Imax	[Arms]	164	203	245	242	342
Minimum switching frequency from inverter		[kHz]	4***	4***	4***	4***	4***
Phase-to-phase resistance @20°C dc mode	Rpp	[mΩ]	95,93	72,27	48,85	25,14	16,96
Phase-to-phase inductance Lq	Lq	[mH]	4,44	3,64	1,92	0,92	0,69
Phase-to-phase inductance Ld	Ld	[mH]	1,68	1,38	0,72	0,36	0,27
Moment of inertia of the rotor	J	[kgm ²]	0,63	0,765	0,63	0,35	0,45
Motor weight		[kg]	284	308	387	298	320
Working temperature		[°C]	-15 ÷ +40				
Degree of protection			IP55				
Insulation class			F				
Service type			S1				
Standard thermal protection			PTC - 150°C				

***Value to be entered in the inverter, any automatic frequency adaptation mode MUST be disabled.

IC 411

EOS 225Sa8 37 kW 1000 rpm 400V

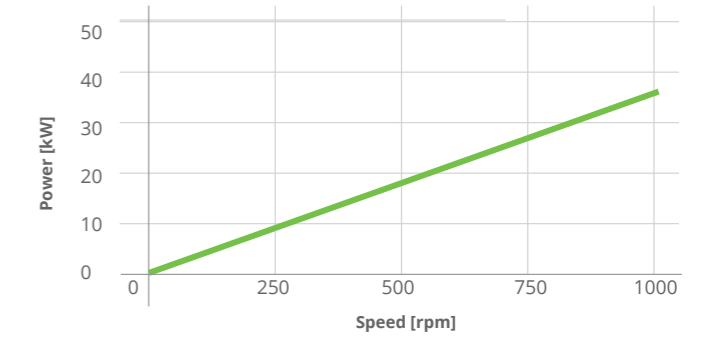
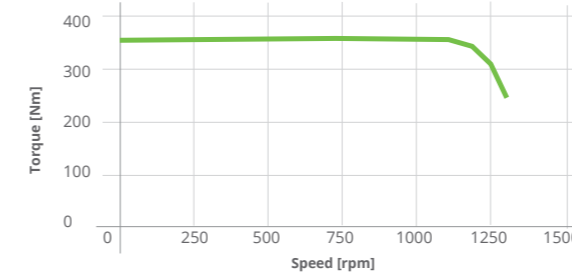

EOS 225Mb8 45 kW 1000 rpm 400V

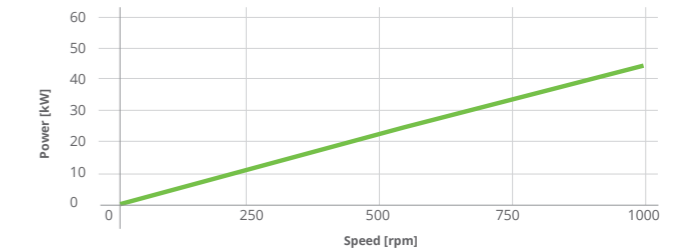
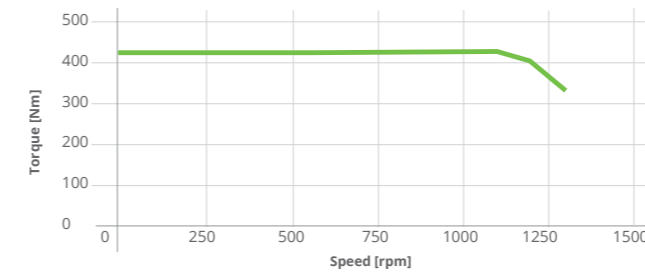

EOS 225Sa8 55 kW 1500 rpm 400V

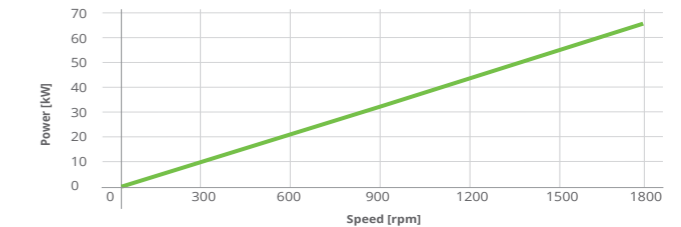
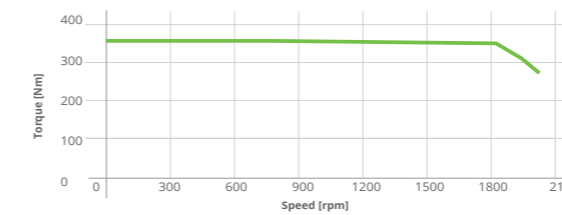

EOS 225Sa8 55 kW 3000 rpm 400V

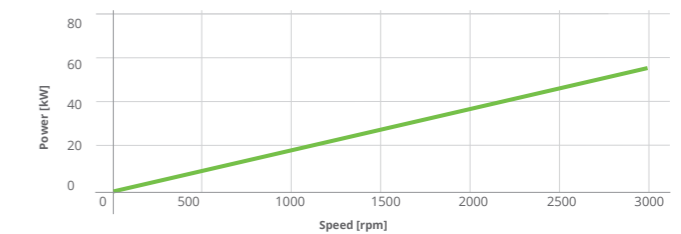
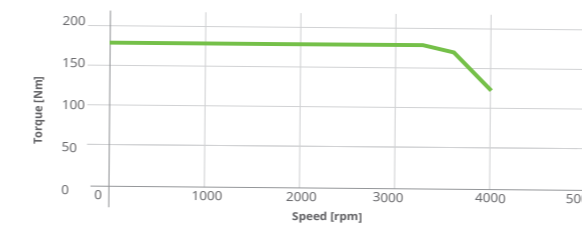

EOS 225Sb8 75 kW 3000 rpm 400V

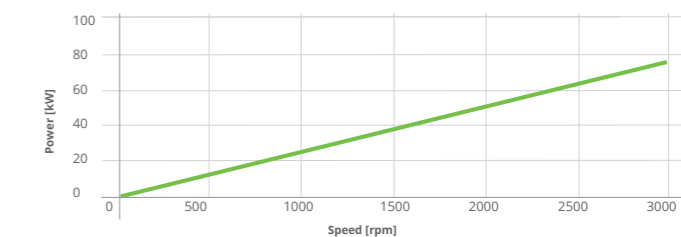
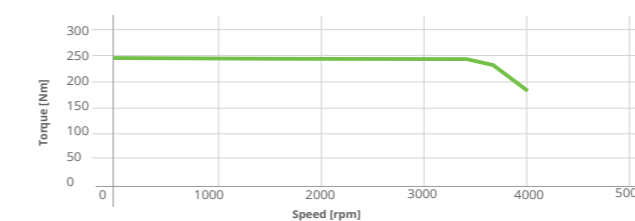



EOS 250Ma8 EOS 250Mb8 EOS 250Mc8 EOS 250Ma8 EOS 250Mb8

Inverter power supply 400 Vac

MOTOR IC411 (auto-ventilated) 55 kW 75 kW 90 kW 90 kW 110 kW

HOUSING IN CAST IRON			RATED SPEED (n_N)				
Description	Symbol	Unit of measure	1000 rpm	1500 rpm	1500 rpm	3000 rpm	3000 rpm
Frequency	f	[Hz]	66,7	100	100	200	200
Number of Poles			8	8	8	8	8
Maximum speed	n_{MAX}	[rpm]	1100	1650	1650	3300	3300
Voltage constant (connected) $\pm 5\%$	K_e	[Vrms/krpm]	344	229	233	116	117
Torque constant $\pm 5\%$	K_t	[Nm/Arms]	5,59	3,73	3,53	1,89	1,91
Rated torque	M_N	[Nm]	525	477,5	573	286,5	350
Rated current	I_N	[Arms]	95,5	131	162	158	190
Efficiency	η	[%]	95,1	96,0	96,1	95,8	96
Maximum torque	M_{max}	[Nm]	1334	1194	1432	716	875
Current maximum torque	I_{max}	[Arms]	245	343	405	396	488
Minimum switching frequency from inverter		[kHz]	4***	4***	4***	4***	4***
Phase-to-phase resistance @20°C dc mode	R_{pp}	[m Ω]	60,1	30,36	23,9	15,99	10,77
Phase-to-phase inductance L_q	L_q	[mH]	2,87	1,40	1,274	0,59	0,463
Phase-to-phase inductance L_d	L_d	[mH]	1,06	0,52	0,504	0,22	0,173
Moment of inertia of the rotor	J	[kgm ²]	0,94	0,86	1,105	0,53	0,686
Motor weight		[kg]	383	440	440	377	401
Working temperature		[°C]	-15 ÷ +40				
Degree of protection			IP55				
Insulation class			F				
Service type			S1				
Standard thermal protection			PTC - 150°C				

***Value to be entered in the inverter, any automatic frequency adaptation mode MUST be disabled.

IC 411

EOS 250Ma8 55 kW 1000 rpm 400V

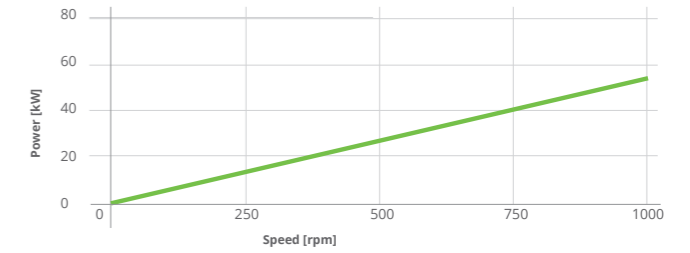
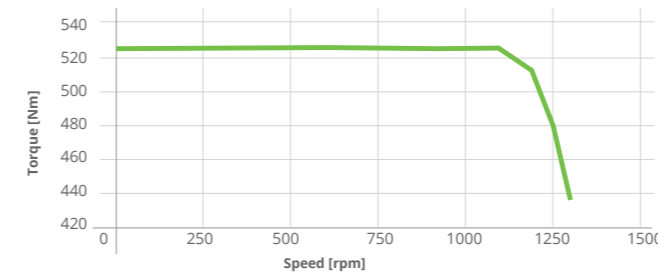

EOS 250Mb8 75 kW 1500 rpm 400V

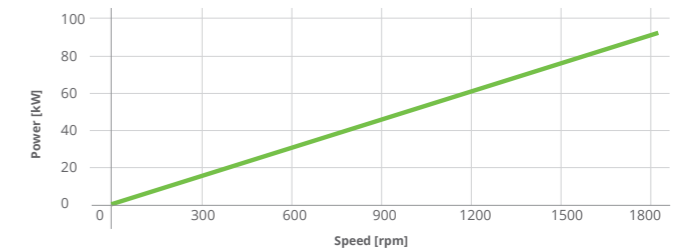
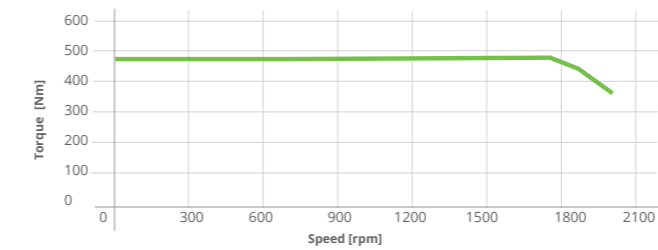

EOS 250Mc8 90 kW 1500 rpm 400V

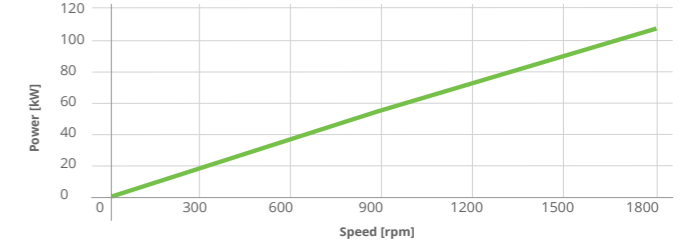
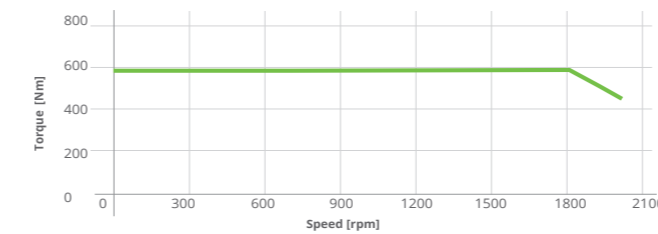

EOS 250Ma8 90 kW 3000 rpm 400V

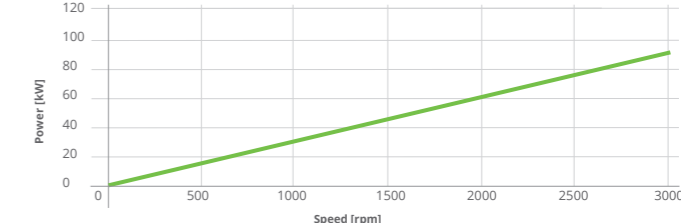
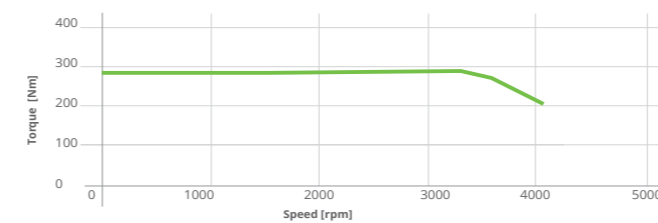

EOS 250Mb8 110 kW 3000 rpm 400V

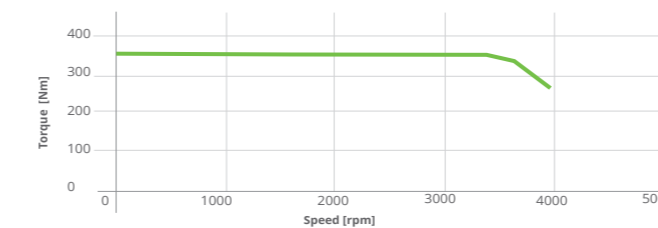



EOS 280 Sa8 EOS 280 Sb8 EOS 280 Ma8 EOS 280 Sb8 EOS 280 Ma8 EOS 280 Sa8 EOS 280 Sb8 EOS 280 Ma8 EOS 280 Mb8

Inverter power supply 400 Vac

MOTOR IC411 (auto-ventilated)

75 kW 90 kW 110 kW 110 kW 132 kW 132 kW 160 kW 200 kW 250 kW

HOUSING IN CAST IRON			RATED SPEED (n _n)								
Description	Symbol	Unit of measure	1000 rpm			1500 rpm			3000 rpm		
Frequency	f	[Hz]	66,7	66,7	66,7	100	100	200	200	200	200
Number of Poles			8	8	8	8	8	8	8	8	8
Maximum speed	n _{MAX}	[rpm]	1100	1100	1100	1650	1650	3300	3300	3300	3300
Voltage constant (connected) ±5%	Ke	[Vrms/krpm]	344	342	338	227	228	118	116	114	116
Torque constant ±5%	Kt	[Nm/Arms]	5,59	5,54	5,44	3,65	3,69	1,89	1,85	1,83	1,88
Rated torque	M _N	[Nm]	716	859,5	1050,5	700	840	420	509	637	796
Rated current	I _N	[Arms]	131	158	193	195	234	230	280	390	435
Efficiency	η	[%]	95,4	95,6	95,8	96,3	96,4	96,2	96,3	96,5	96,5
Maximum torque	Mmax	[Nm]	1790	2148	2626	1750	2135	1050	1272	1590	1990
Current maximum torque	Imax	[Arms]	330	395	483	492	600	575	700	975	1038
Minimum switching frequency from inverter		[kHz]	4***	4***	4***	4***	4***	4***	4***	4***	4***
Phase-to-phase resistance @20°C dc mode	Rpp	[mΩ]	38,53	24,53	20,04	15,79	10,47	9,56	7,23	3,824	2,562
Phase-to-phase inductance Lq	Lq	[mH]	2,10	1,93	1,65	1,11	0,86	0,500	0,414	0,2776	0,222
Phase-to-phase inductance Ld	Ld	[mH]	0,77	0,55	0,48	0,32	0,25	0,146	0,121	0,0822	0,0633
Moment of inertia of the rotor	J	[kgm ²]	1,29	2,01	2,24	1,5	2,01	0,89	1,02	1,51	2,05
Motor weight		[kg]	425	501	573	560	608	480	515	570	608
Working temperature		[°C]	-15 ÷ +40								
Degree of protection			IP55								
Insulation class			F								
Service type			S1								
Standard thermal protection			PTC - 150°C								

EOS 280Sa8 75 kW 1000 rpm 400V

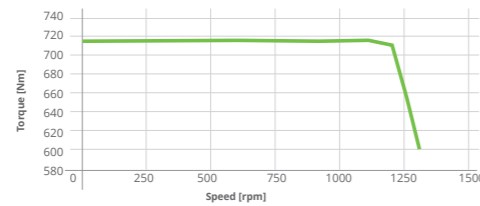

EOS 280Sb8 90 kW 1000 rpm 400V

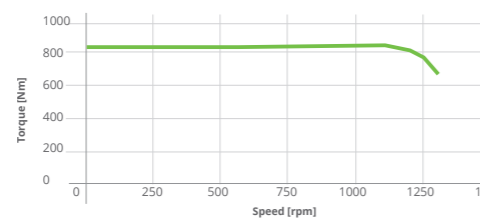

***Value to be entered in the inverter, any automatic frequency adaptation mode MUST be disabled.

IC 411

EOS 280Ma8 110 kW 1000 rpm 400V

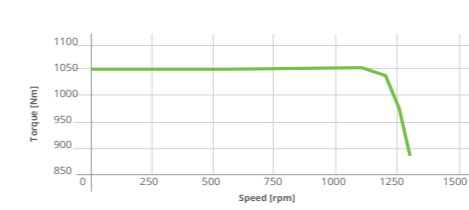

EOS 280Sb8 110 kW 1500 rpm 400V

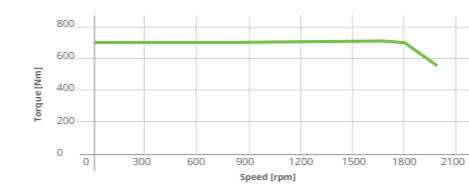

EOS 280Ma8 132 kW 1500 rpm 400V

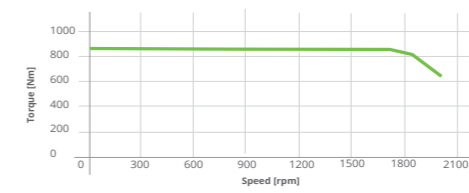

EOS 280Sa8 132 kW 3000 rpm 400V

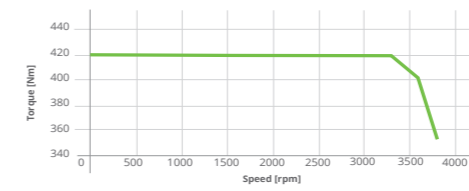

EOS 280Sb8 160 kW 3000 rpm 400V

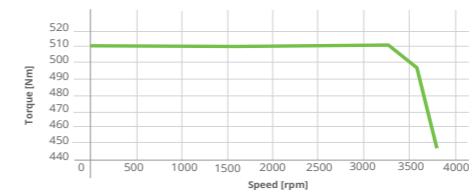

EOS 280Ma8 200 kW 3000 rpm 400V

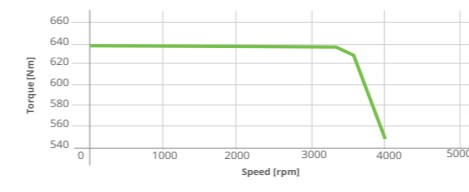

EOS 280Mb8 250 kW 3000 rpm 400V

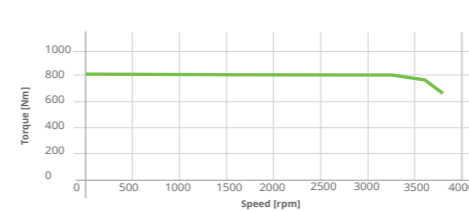



EOS 315Sb8 EOS 315La8 EOS 315Sa8 EOS 315Mb8 EOS 315Mc8

Inverter power supply 400 Vac

MOTOR IC411 (auto-ventilated) 132 kW 160 kW 160 kW 200 kW 250 kW

HOUSING IN CAST IRON			RATED SPEED (n_n)				
Description	Symbol	Unit of measure	1000 rpm	1500 rpm	3000 rpm		
Frequency	f	[Hz]	66,7	66,7	100	100	100
Number of Poles			8	8	8	8	8
Maximum speed	n_{MAX}	[rpm]	1100	1100	1650	1650	1650
Voltage constant (connected) $\pm 5\%$	Ke	[Vrms/krpm]	338	358	229	238,5	241
Torque constant $\pm 5\%$	Kt	[Nm/Arms]	5,41	5,52	3,72	3,65	3,66
Rated torque	M_N	[Nm]	1261	1528	1019	1273	1592
Rated current	I_N	[Arms]	235	280	280	355	444
Efficiency	η	[%]	96,0	96,2	96,4	96,7	96,7
Maximum torque	Mmax	[Nm]	3150	3820	2546	3182	3979
Current maximum torque	Imax	[Arms]	578	700	715	893	1116
Minimum switching frequency from inverter		[kHz]	4***	4***	4***	4***	4***
Phase-to-phase resistance @20°C dc mode	Rpp	[m Ω]	17,05	97,24	8,23	6,03	4,75
Phase-to-phase inductance Lq	Lq	[mH]	1,41	1,04	0,72	0,58	0,482
Phase-to-phase inductance Ld	Ld	[mH]	0,41	0,29	0,21	0,16	0,137
Moment of inertia of the rotor	J	[kgm ²]	2,56	4,21	2,43	3,28	3,97
Motor weight		[kg]	615	843	670	1125	1220
Working temperature		[°C]	-15 ÷ +40				
Degree of protection			IP55				
Insulation class			F				
Service type			S1				
Standard thermal protection			PTC - 150°C				

***Value to be entered in the inverter, any automatic frequency adaptation mode MUST be disabled.

IC 411

EOS 315Sb8 132 kW 1000 rpm 400V

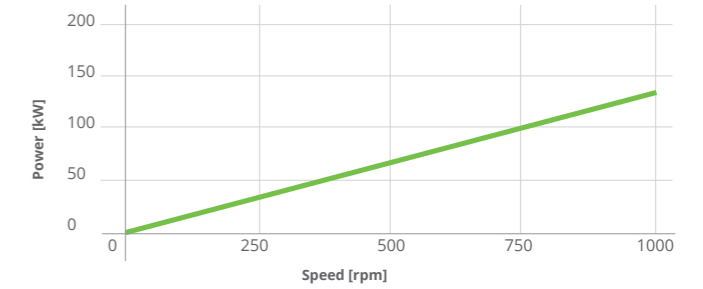
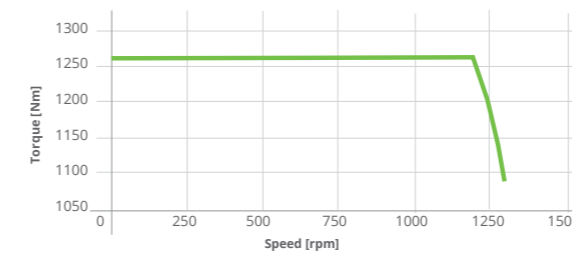

EOS 315La8 160 kW 1000 rpm 400V

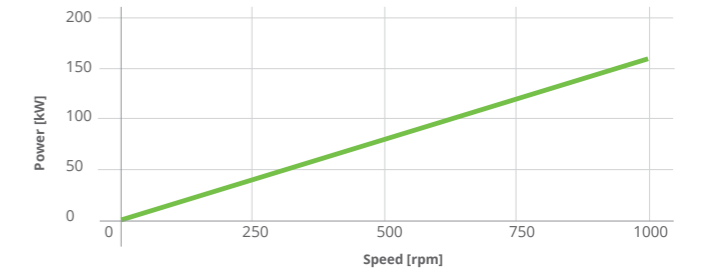
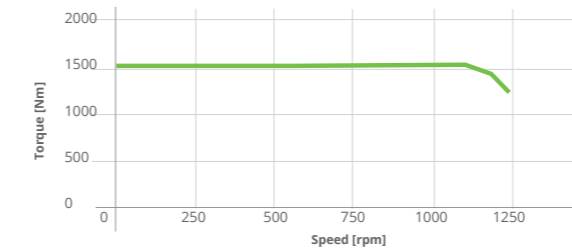

EOS 315sa8 160 kW 1500 rpm 400V

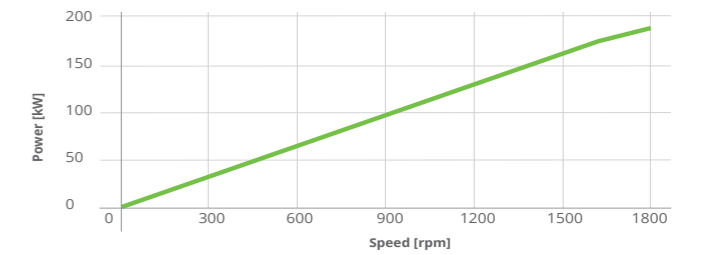

EOS 315Mb8 200 kW 1500 rpm 400V

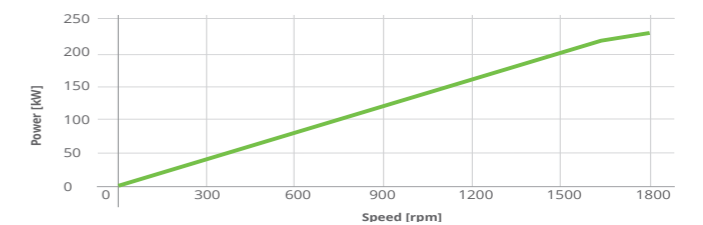
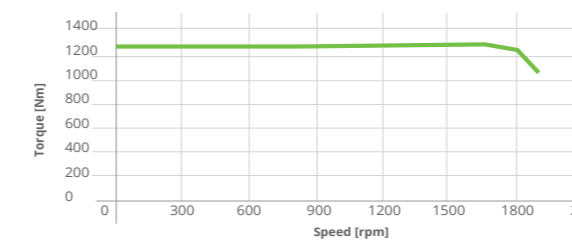

EOS 315Mc8 250 kW 1500 rpm 400V

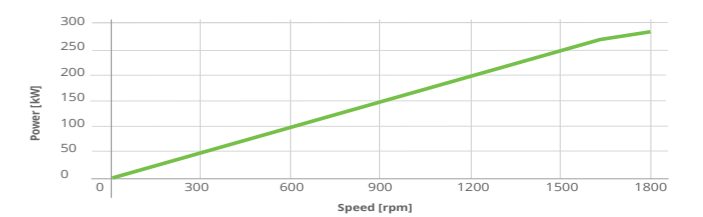
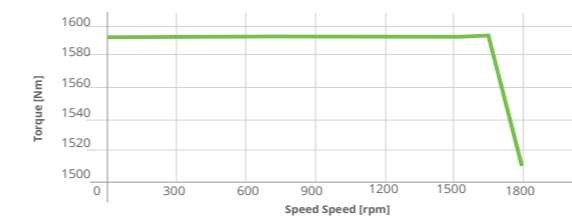



EOS 355Ma8 EOS 355Mb8

Inverter power supply 400 Vac

MOTOR IC411 (auto-ventilated) 200 kW 250 kW

HOUSING IN CAST IRON			RATED SPEED (n _n)	
Description	Symbol	Unit of measure	1000 rpm*	
Frequency	f	[Hz]	66,7	66,7
Number of Poles			8	8
Maximum speed	n _{MAX}	[rpm]	1100	1100
Voltage constant (connected) ±5%	Ke	[Vrms/krpm]	358	358,5
Torque constant ±5%	Kt	[Nm/Arms]	5,46	5,44
Rated torque	M _N	[Nm]	1910	2388
Rated current	I _N	[Arms]	355	444
Efficiency	η	[%]	96,3	96,5
Maximum torque	Mmax	[Nm]	4775	5968
Current maximum torque	Imax	[Arms]	872	1090
Minimum switching frequency from inverter		[kHz]	4***	4***
Phase-to-phase resistance @20°C dc mode	Rpp	[mΩ]	77,13	6,13
Phase-to-phase inductance Lq	Lq	[mH]	0,87	0,71
Phase-to-phase inductance Ld	Ld	[mH]	0,24	0,20
Moment of inertia	J	[kgm ²]	4,89	5,88
Motor weight		[kg]	941	1017
Working temperature		[°C]	-15 ÷ +40	
Degree of protection			55	
Insulation class			F	
Service type			S1	
Standard thermal protection			PTC - 150°C	



EOS 355Ma8 200 kW 1000 rpm 400V

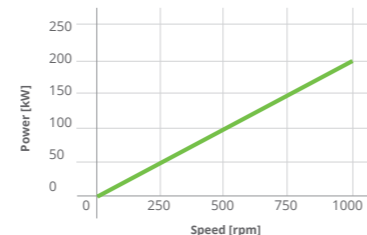
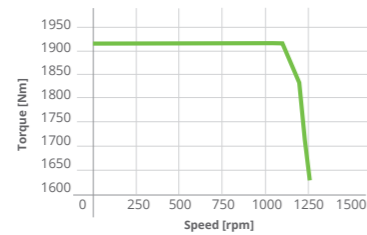

EOS 355Mb8 250 kW 1000 rpm 400V

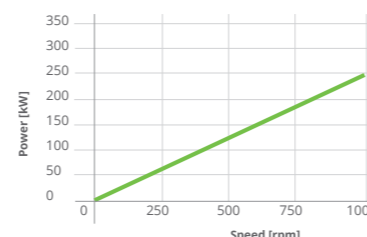

*Preferential winding. **Values declared with current id=0A. ***Value to be entered in the inverter, any automatic frequency adaptation mode MUST be disabled.

IC 411



9. ELECTRICAL CONNECTIONS by size UP TO an axis height 160L

Triangle connection (High speed)

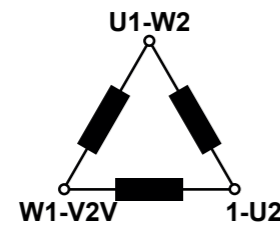
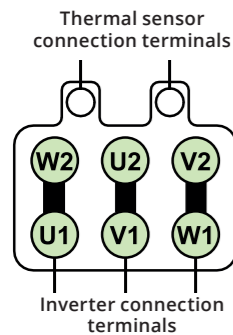

Star connection (Low speed)

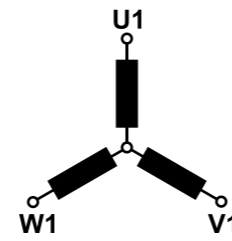
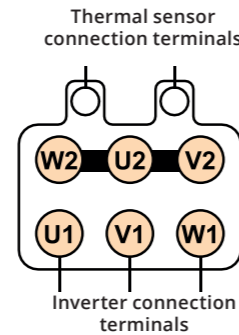

Ground: The metal parts of the motor that are not normally live must be connected to the ground using the appropriately marked terminal, placed inside the terminal box, (using a suitable section cable).

Speed transducers connection

The transducer can be connected to:
 • Dedicated inputs of the motor control electronics; in this case, the encoder is used for the motor speed control;
 • External control devices; in this case the encoder is not used for motor speed control.
 For further information or connection diagrams, contact the SEIPEE S.p.A. technical office.

Anti-condensation heater connection

The terminals are placed inside the motor terminal box. Before connecting, check the characteristics indicated on the adhesive plate located inside the terminal box, which identifies the type of protection (check the power supply data).

The heater must not be powered during while the motor is running.

Axial servo-fan connection

Power terminals placed inside an auxiliary terminal box integral with the fan cover. Before connecting, check the characteristics indicated on the adhesive identification label (check the power supply data).

Parking brake connection

Refer to the connection diagram inserted in the motor terminal box.

For further information, contact the SEIPEE S.p.A. technical office.

Important: at the end of the connections, check the electrical terminals are correctly tightened, position the gasket correctly and close the terminal box.

10. ELECTRICAL CONNECTIONS by size with axis height FROM 180L and higher

Connection (Single speed)

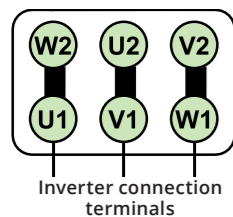

NOTE: from size 180L upwards, there is a star connection with the connection centre implemented inside the motor. The motor is supplied with the plates in a delta configuration to also take advantage of the second row of terminals.

11. ELECTRICAL CONNECTIONS - WARNINGS

EOS and ZEPHYRUS motors are only suitable for operation with variable speed drive.

DIRECT START-UP FROM THE POWER SUPPLY MAINS CAUSES IRREVERSIBLE DAMAGE TO THE MOTOR.

Before making the electrical connection, make sure that the power supply matches the electrical data shown on the rating plate.

Cables: Use cables with a suitable section in order to avoid overheating and/or excessive voltage drop at the motor terminals.

Connect the winding in the Y or Δ configuration to the terminal block according to the data shown on the motor plate or the performances reported in the following manual.

12. DIMENSIONS AND STANDARDIZED

12.1 Construction forms and assembly positions

The expected construction forms are IM B3, IM B5, IM B14 and combined forms IM B35 (B3/B5) and IM B34 (B3/B14). The motors can also work in the corresponding vertical axis construction shapes. When requesting the motor, specific the complete IM code. Consult the tables to check for any restrictions. The motor plate indicates the structural format with horizontal axis. The structural formats and mounting positions are shown in the table below.

MOTORS WITH FIXING FEET		SIZE				
		56+160	180+250	280+315	355	
IM B3 IM 1001		• Horizontal axis • Feet arranged downwards	●	●	●	●
IM B6 IM 1051		• Horizontal axis • Feet arranged downwards	●	●	○	
IM B7 IM1061		• Horizontal axis • Feet to the right with a view from the command side	●	●	○	
IM B8 IM 1071		• Horizontal axis • Feet arranged upwards	●	●	○	
IM V5 IM 1011		• Vertical axis • Wall-mounted feet with shaft output downwards	●	●	○	
IM V6 IM 1031		• Vertical axis • Wall-mounted feet with shaft output upwards	●	●	○	

Legend: ● Possible ○ Consult Seipee

MOTORS WITH FIXING FLANGE WITH THROUGH HOLES			SIZE			
			56÷160	180÷250	280÷315	355
IM B5 IM 3001		<ul style="list-style-type: none"> Horizontal axis Shaft output side shield with through holes 	●	●	○	○
IM V1 IM 3011		<ul style="list-style-type: none"> Vertical axis Shaft output side shield with through holes Shaft output pointing downwards 	●	●	●	●
IM V3 IM 3031		<ul style="list-style-type: none"> Vertical axis Shaft output side shield with through holes Shaft output pointing upwards 	●	●	○	
IM B35 IM 2001		<ul style="list-style-type: none"> Horizontal axis Feet arranged downwards Shaft output side shield with through holes Fixing by means of feet and flange 	●	●	●	●
IM V15 IM 2011		<ul style="list-style-type: none"> Vertical axis Wall-mounted feet with shaft output downwards Shaft output side shield with through holes Fixing by means of feet and flange 	●	●	●	●
IM V36 IM 2031		<ul style="list-style-type: none"> Vertical axis Wall-mounted feet with shaft output upwards Shaft output side shield with through holes Fixing by means of feet and flange 	●	●	○	

MOTORS WITH FIXING FLANGE WITH THREADED HOLES			SIZE			
			56÷160	180÷250	280÷315	355
IM B14 IM 3601		<ul style="list-style-type: none"> Horizontal axis Shaft output side shield with through holes 	●			
IM V19 IM 3631		<ul style="list-style-type: none"> Vertical axis Shaft output side shield with through holes Shaft output pointing upwards 	●			
IM B34 IM 2101		<ul style="list-style-type: none"> Horizontal axis Feet arranged downwards Shaft output side shield with through holes Fixing by means of feet and flange 	●			
IM V18 IM 3611		<ul style="list-style-type: none"> Vertical axis Shaft output side shield with through holes Shaft output pointing downwards 	●			

Legend: ● Possible ○ Consult Seipee

EOS/ZEPH 56÷160 motors (Aluminium)

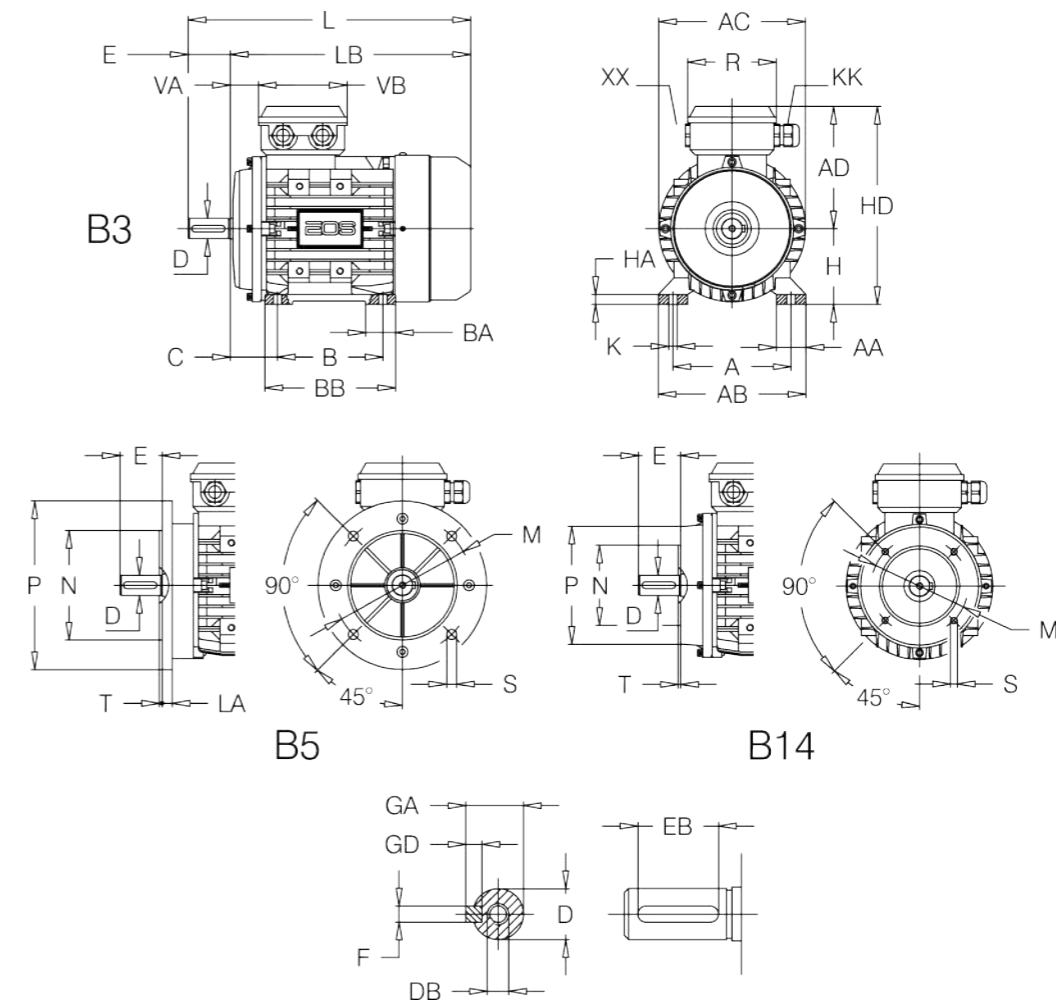

MOTOR	Main dimensions					Feet							Flange									
	AC	AD	H	HD	LB	L	A	B	C	AB	BB	A A	B A	H A	K	IM	M	N j6	P	L A	T	S
EOS/ZEPH 56	112	98	56	154	176	196	90	71	36	110	89	20	20	6	6X9	B5 B14	100 65	80 50	120 80	8 —	3 2,5	7 M5
EOS/ZEPH 63	122	110	63	173	200	223	100	80	40	120	103	28	26	8,5	7X10	B5 B14	115 75	95 60	140 90	9 —	3 2,5	9 M5
EOS/ZEPH 71	139	116	71	187	231	261	112	90	45	133	106	28	23	10	7X10	B5 B14	130 85	110 70	160 105	9 —	3,5 2,5	10 M6
EOS/ZEPH 80	157	135	80	215	254	294	125	100	50	160	130	35	35	11	10X13	B5 B14	165 100	130 80	200 120	10 —	3,5 3	12 M6
EOS/ZEPH 90S	174	143	90	233	258	308	140	100	56	175	130	35	33	12	10X13	B5 B14	165 115	130 95	200 140	12 —	3,5 3	12 M8
EOS 90 L	174	143	90	233	283	333	140	125*	56	175	155	35	33	12	10X13	B5 B14	165 115	130 95	200 140	12 —	3,5 3	12 M8
ZEPH 90 L	174	143	90	233	258	308	140	125*	56	175	155	35	33	12	10X13	B5 B14	165 115	130 95	200 140	12 —	3,5 3	12 M8
EOS/ZEPH 100	196	153	100	253	332	392	160	140	63	198	176	50	42	15	12X16	B5 B14	215 130	180 110	250 160	13 —	4 3,5	15 M8
EOS/ZEPH 112	221	174	112	286	334	394	190	140	70	220	180	55	42	15	12X15	B5 B14	215 130	180 110	250 160	14 —	4 3,5	15 M8
EOS/ZEPH 132M	258	193	132	325	390	470	216	178	89	252	213	58	40	15	13X16	B5 B14	265 165	230 130	300 200	14 —	4 3,5	15 M10
EOS/ZEPH 160L	314	235	160	395	530	640	254	254*	108	291	293	54	90	17	16X20	B5 B14	300 215	250 180	350 250	15 —	5 4	20 M12

* The 90L foot also has a centre distance of 100 mm and the 160L foot also has a centre distance of 210 mm.

Size	Shaft End						Seals on the shaft			Terminal box							
	Tab				N°-Ø	N°-KK	N°-XX	Ømax	VA	VB	R	Terminal	Cable gland	Plug	Cable		
	D	DB	E	GA												F	GD
56	9 j6	M4	20	10,2	3	3	12	12	22	5	6-M4	1-M16x1,5	1-M16x1,5	8	14	88	88
63	11 j6	M4	23	12,4	4	4	16	12	24	7	6-M4	1-M20x1,5	1-M20x1,5	12	17	95	95
71	14 j6	M5	30	16	5	5	22	15	25	7	6-M4	1-M20x1,5	1-M20x1,5	12	21	94	94
80	19 j6	M6	40	21,5	6	6	32	20	35	7	6-M4	1-M20x1,5	1-M20x1,5	12	27,5	105	105
90S	24 j6	M6	50	27	8	7	40	25	37	7	6-M4	1-M25x1,5	1-M25x1,5	15	32	105	105
90L	24 j6	M8	50	27	8	7	40	25	37	7	6-M4	1-M25x1,5	1-M25x1,5	15	32	105	105
100L	28 j6	M10	60	31	8	7	50	30	42	7	6-M5	1-M25x1,5	1-M25x1,5	15	27	105	105
112M	28 j6	M10	60	31	8	7	50	30	44	7	6-M5	1-M25x1,5	1-M25x1,5	15	32	112	119
132M	38 k6	M12	80	41	10	8	70	40	58	8	6-M5	1-M32x1,5	1-M32x1,5	21	37	112	119
160L	42 k6	M16	110	45	12	8	90	45	65	8	6-M6	1-M40x1,5	1-M16x1,5 1-M40x1,5	30	65	143	146

EOS 180÷355 motors (Cast iron)

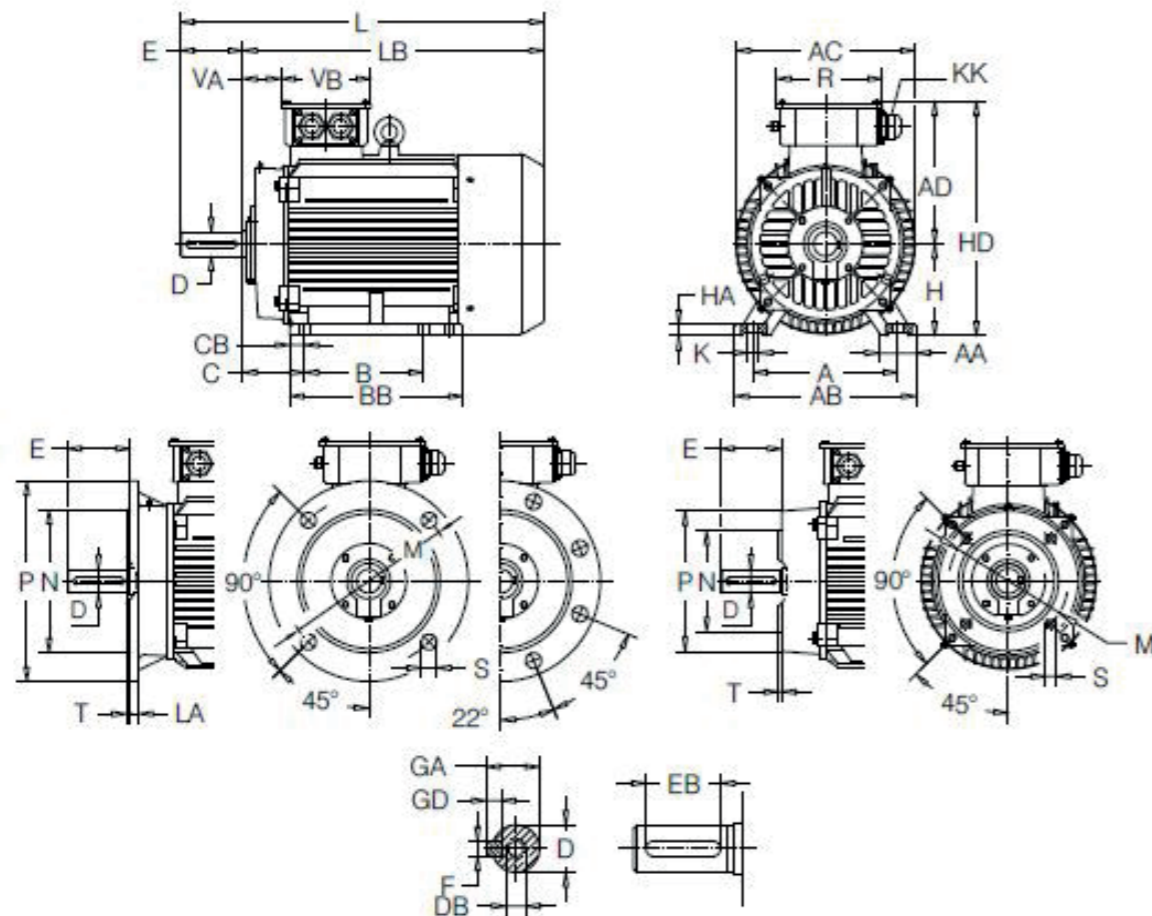

MOTOR	Main dimensions						Feet						Flange									
	AC	AD	H	HD	LB	L	A	B	C	AB	BB	A A	B A	H A	K	IM	M	N j6	P	L A	T	S
180 M L 2-4 4-6	355	267	180	447	578 616	688 726	279	241 279	121	350	311 349	70	35	22	15	B5	300	250	350	15	5	N°4 19
200 L 2 4-6	397	299	200	499	669	779	318	305	133	390	370	70	32	25	18	B5	350	300	400	17	5	N°4 19
225 S 2 4	446	322	225	547	684	794 824	356	286	149	432	370	75	46	28	19	B5	400	350	450	20	5	N°8 19
225 M 2 4-6	446	322	225	547	709	819 849	356	311	149	433	395	75	46	28	19	B5	400	350	450	20	5	N°8 19
250 M 2 4-6	485	358	250	608	770	910	406	349	168	486	445	80	55	30	24	B5	500	450	550	22	5	N°8 19
280 S 2 4-6	547	387	280	667	893	1033	457	419	190	545	536	85	69	35	24	B5	500	450	550	22	5	N°8 19
280 M 2 4-6	547	387	280	667	893	1033	457	419	190	545	536	85	69	35	24	B5	500	450	550	22	5	N°8 19
315 S 2 4-6	620	541	315	856	1038	1178 1208	508	406	216	630	570	120	84	45	28	B5	600	550	660	22	6	N°8 24
315 M 2 4-6	620	541	315	856	1148	1288 1318	508	457	216	630	680	120	84	45	28	B5	600	550	660	22	6	N°8 24
315 L 2 4-6	620	541	315	856	1148	1288 1318	508	508	216	630	680	120	84	45	28	B5	600	550	660	22	6	N°8 24
355 M 2 4-6	698	642	355	997	1346	1486 1556	610	560	254	730	750	120	68	52	28	B5	740	680	800	25	6	N°8 24
355 L 2 4-6	698	642	355	997	1346	1486 1556	610	630	254	730	750	120	68	52	28	B5	740	680	800	25	6	N°8 24

MOTOR	Shaft End						Seals on the shaft						Terminal box						
	D	DB	E	GA	F	GD	EB	Øi	Øe	H	Øi	Øe	H	N°-Ø	N°-KK	N°-XX	VA	VB	R
180 M L 2-4 4-6	48	M16	110	51,5	14	9	90	55	75	8/12	55	75	8/12	6-M6	2-M40x1,5	1-M16x1,5	82	158	185
200 L 2 4-6	55	M20	110	59	16	10	100	60	80	8/12	60	80	8/12	6-M8	2-M50x1,5	1-M16x1,5	92	187	224
225 S 2 4 60	55	M20	110	59	16	10	100	60	80	8/12	60	80	8/12	6-M8	2-M50x1,5	1-M16x1,5	95	187	224
225 M 2 4-6 60	55	M20	110	59	16	10	100	60	80	8/12	60	80	8/12	6-M8	2-M50x1,5	1-M16x1,5	95	187	224
250 M 2 4-6 65	60	M20	140	64	18	11	125	65	90	10/12	65	90	10/12	6-M10	2-M63x1,5	1-M16x1,5	88	238	283
280 S 2 4-6 75	65	M20	140	69	18	11	125	70	90	10/12	70	90	10/12	6-M10	2-M63x1,5	1-M16x1,5	96	238	283
280 M 2 4-6 75	65	M20	140	69	18	11	125	70	90	10/12	70	90	10/12	6-M10	2-M63x1,5	1-M16x1,5	96	238	283
315 S 2 4-6 80	65	M20	140	69	18	11	125	85	110	10/12	85	110	10/12	6-M12/16	2-M63x1,5	1-M16x1,5	117	280	320
315 M 2 4-6 80	65	M20	140	69	18	11	125	85	110	10/12	85	110	10/12	6-M12/16	2-M63x1,5	1-M16x1,5	117	280	320
315 L 2 4-6 80	65	M20	140	69	18	11	125	85	110	10/12	85	110	10/12	6-M12/16	2-M63x1,5	1-M16x1,5	117	280	320
355 M 2 4-6 100	75	M20	140	79,5	20	12	125	95	120	10/12	95	120	10/12	6-M20	2-M63x1,5	1-M16x1,5	117	328	380
355 L 2 4-6 100	75	M20	140	79,5	20	12	125	95	120	10/12	95	120	10/12	6-M20	2-M63x1,5	1-M16x1,5	117	328	380

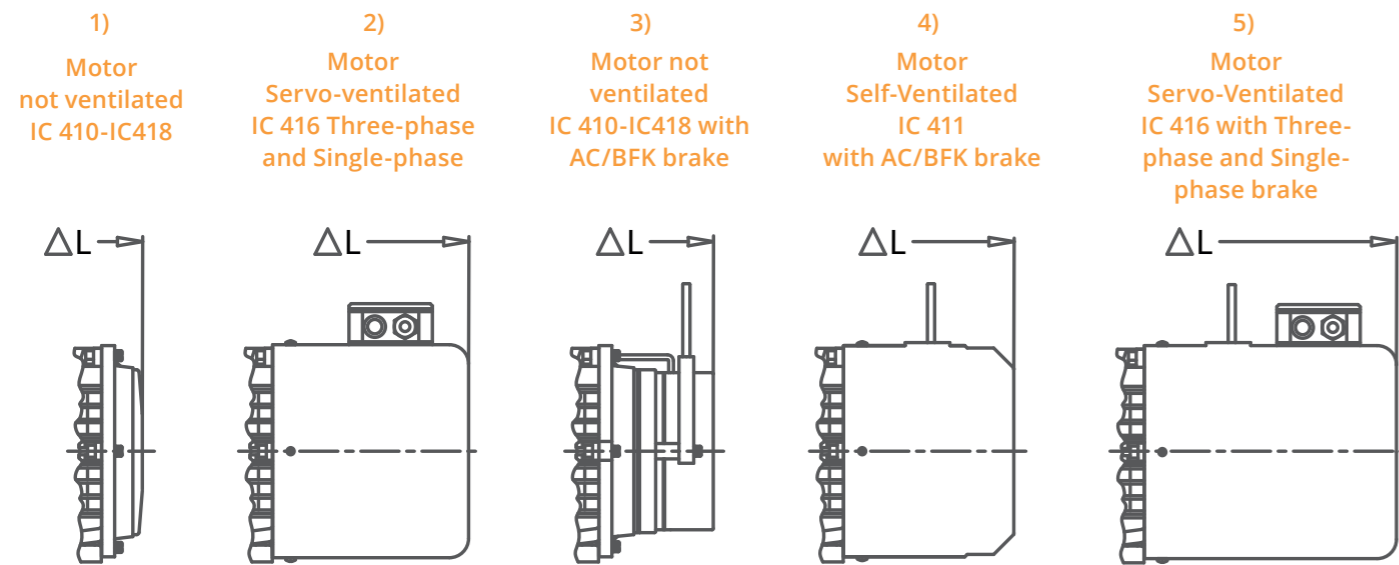

VERSION (ALUMINIUM)	INCREASE MEASUREMENT ON TOTAL LENGTH	56	63	71	80	90S/L	100	112	132	160
1) NOT VENTILATED IC410-IC418	ΔL	-35	-40	-45	-50	-50	-60	-60	-65	-95
2) SERVO-VENTILATED IC416 - Three-phase	ΔL	--	--	120	120	100	80	80	90	180
2) SERVO-VENTILATED IC416 - Single-phase	ΔL	--	60	55	70	70				
3) BFK BRAKE NOT VENTILATED IC410-IC418	ΔL	5	5	10	-5	-5	0	15	20	-10
3) AC BRAKE NOT VENTILATED IC410-IC418	ΔL	--	15	20	10	15	20	20	35	0
4) BFK/AC BRAKE VENTILATED IC411	ΔL	40	45	60	60	60	75	80	105	80
5) BFK/AC BRAKE SERVO-VENTILATED IC416 - Three-phase	ΔL	--	--	205	195	175	140			
5) BFK/AC BRAKE SERVO-VENTILATED IC416 - Single-phase	ΔL	--	135	140	130	150	160	170	185	160

VERSION (CAST IRON)	INCREASE MEASUREMENT ON TOTAL LENGTH	180		200	225		280		315		355
		M	L		S	M	S	M	S	M-L	M-L
1) NOT VENTILATED IC410-IC418	ΔL	-100		-105	-120		-112		-125		-165
2) SERVO-VENTILATED IC416 - Three-phase	ΔL	170		200	190		200		225		210

Rain protection roof (option P01)

Execution required for outdoor applications or in the presence of water splashes, with vertical shaft pointing downwards, type of construction (IM V5, IM V1, IM V18, IM V15, IM V17).

The LB dimension increases by:

- 35 mm size 56÷112
- 45 mm size 132÷160
- 65 mm size 180÷225
- 85 mm size 250÷355

13. POSSIBLE MOTOR CONFIGURATIONS

13.1 Ventilation options

EOS/ZEPHYRUS range motors are supplied, in the standard version, with the following configuration:

- IC411 cooling system (self-ventilated)
- Without parking brake
- Without speed transducer (encoder, resolver...)

Other configurations are shown in the following table and are provided as options, which must be specified when ordering:

Optionally, the following versions are available:

- • IC416 servo-ventilated: suitable for applications requiring constant load torque at low revs where normally the IC411 self-ventilated motor requires a derating as shown in the graphs of the performance cards of the various motors of the EOS range. The ZEPHYRUS range does not require a servo-ventilated version even at low revs.
- • IC410 non-ventilated: suitable for applications that do not allow proper ventilation.

MOTOR	Auxiliary fan characteristics Specifications of the independent axial cooling fan							Weight [kg]
	Phases	V ~ ± 5%	Hz	W _{ass}	A _{ass}	Poles	Protection	
63	1	230	50 / 60	22 / 21	0,14 / 0,12	2	IP55	0,8
71	1	230	50 / 60	22 / 21	0,14 / 0,12	2	IP55	0,9
	3	Y - 400	50 / 60	90	0,24 / 0,19			2,2
80	1	230	50 / 60	22 / 21	0,14 / 0,12	2	IP55	1,4
	3	Y - 400	50 / 60	90	0,24 / 0,19			2,3
90	1	230	50 / 60	39 / 36	0,28 / 0,24	2	IP55	1,5
	3	Y - 400	50 / 60	90	0,24 / 0,19			2,4
100	1	230	50 / 60	39 / 36	0,28 / 0,24	2	IP55	1,9
	3	Y - 400	50 / 60	45 / 43	0,13 / 0,09			IP54
112	1	230	50 / 60	64 / 78	0,30 / 0,34	2	IP55	2,2
	3	Y - 400	50 / 60	68 / 70	0,17 / 0,13			IP54
132	1	230	50 / 60	64 / 78	0,30 / 0,34	2	IP54	2,8
	3	Y - 400	50 / 60	68 / 70	0,17 / 0,13			3,2
160	3	Y - 400 / 480	50 / 60	43 / 62	0,31 / 0,35	4	IP55	8,0
180	3	Y - 400 / 480	50 / 60	97/138	0,32/0,35	4	IP55	9,0
200	3	Y - 400 / 480	50 / 60	81/116	0,22/0,24	6	IP55	11,0
225	3	Y - 400 / 480	50 / 60	115/169	0,25/0,28	6	IP55	12,0
250	3	Y - 400 / 480	50 / 60	114/168	0,24/0,27	6	IP55	14,0
280	3	Y - 400 / 480	50 / 60	187/262	0,64/0,70	8	IP55	19,0
315	3	Y - 400 / 480	50 / 60	199/285	0,64/0,70	8	IP55	24,0
355	3	Y - 400 / 480	50 / 60	238/349	0,64/0,72	8	IP55	29,0

13.2 | Parking Brake Option

The brake acts in the absence of power supply due to the force exerted by the springs. By removing the power supply to the electromagnet, the mobile anchor, by acting on the springs, presses the brake disc keyed onto the crankshaft against the rear shield, generating the braking torque. By powering the brake, the electromagnet, overcoming the force of the springs, attracts the mobile anchor and releases the brake disc and the crankshaft. The construction with multiple springs and the braking in the absence of the power supply make the equipment safe.

- **Alternating current brake: TA series.**
- **Intorq direct current brake: BFK series**
- **Type of service S1.**
- **Class F insulation, class B over-temperature.**
- **Standard degree of protection IP54, contact the SEIPEE S.p.A. technical office for higher degrees of protection (motor protected IP55).**

- **Brake connected to an auxiliary terminal block inside the terminal box. Separate brake supply as standard.**

On request:

- **Manual release lever with automatic return (release lever rod in correspondence with the terminal box and removable).**
- **Predisposition for manual rotation. of the crankshaft by means of a hexagonal male key on the opposite side of the control.**
- Brake power supply using control electronics whose use is compulsory with iMotor branded motors.
- Operation with inverter: the EOS/ZEPHYRUS self-braking series motors are suitable for operation with the inverter.

13.2.1 | TA Series Brakes Characteristics.

- • High switch-on and switch-off speed to allow a completely free starting of the motor, a high braking frequency, a high braking number.
- • Good heat dissipation through the structure made from die-cast aluminium and through the electric motor fan.
- • Steel brake disc.
- • Double friction gasket, silent, without asbestos. Geared steel drive hub with anti-vibration steel O-ring.
- • The minimum value and the rated value of the braking torque are shown on the motor plat
- • Mobile anchor with magnetic lamellar core for greater speed and lower electrical losses.
- • The electromagnet coil is completely cemented with epoxy resin.
- • Possibility to adjust the braking torque.
- • Wide availability of executions, servo-ventilations, encoders, release levers.
- • Motors supplied as standard with brake set at 80% of the rated value of the braking torque ($\pm 15\%$).

Brakes recommended for uses in which powerful and very fast braking is required.

MOTOR	Brake	Static braking torque		Power	Current		Air gap 3)	Clearance of release lever tie rods g ₄₎	Minimum thickness of brache disk s _{min}	
		M _f Minimum ₁₎	M _f Nominal ₂₎		Δ 230V 50Hz	Y 400V 50Hz				
		[Nm]	[Nm]	[W]	[A]	[A]	[mm]	[mm]	[mm]	
EOS/ZEPH	63	TA1	2	4,5	17	0,13	0,07	0,15÷0,50	0,8	5
EOS/ZEPH	71	TA2	3	10	22	0,16	0,09	0,20÷0,60	0,9	5,5
EOS/ZEPH	80	TA3	5	16	27	0,26	0,15	0,20÷0,60	0,9	6
EOS/ZEPH	90	TA4	8	20	29	0,30	0,17	0,25÷0,70	1	6,5
EOS/ZEPH	100	TA5	15	40	49	0,68	0,39	0,25÷0,70	1	6,5
EOS/ZEPH	112	TA6	20	60	60	0,90	0,52	0,25÷0,70	1	6,5
EOS/ZEPH	132	TA7	30	90	69	1,18	0,68	0,30÷0,70	1	7
EOS/ZEPH	160	TA8	60	200	130	1,40	0,80	0,30÷0,70	1	7,5

13.2.2 | BFK series brakes characteristics.

- • Aluminium brake disc.
- • Double friction material, particularly silent, without asbestos.
- • Geared steel drive hub.
- • No axial load on the crankshaft during braking.
- • High braking torque.
- • The rated value of the braking torque are shown on the motor plate.
- • High intervention progressivity both when the motor is started and when braking.
- • Maximum silent operation.
- • The coil of the electromagnet is completely cemented with epoxy resin and the mechanical parts are protected by galvanizing treatment.

Brakes recommended for uses in which regular and silent braking and starting are required..

MOTOR	Motor Size	Brake	Static braking torque		Power	Supply Voltage	Absorbed Current	Release Time	Engagement Time
			M _r Minimum ₁₎	M Nominal ₂₎					
			[Nm]	[Nm]					
EOS/ZEPH	63	BFK457-06	--	6	20	24	0,82	48	37
EOS/ZEPH	71	BFK457-08	--	12	25	24	1,05	95	42
EOS/ZEPH	80	BFK457-08	--	12	25	24	1,05	95	42
EOS/ZEPH	90 S/L	BFK457-10	--	23	30	24	1,25	95	100
EOS/ZEPH	100	BFK457-12	--	46	40	24	1,67	98	135
EOS/ZEPH	112	BFK457-14	--	95	50	24	2,10	107	240
EOS/ZEPH	132	BFK457-16	--	125	55	24	2,30	121	275
EOS/ZEPH	160	BFK458-18	65	150	85	24	3,55	165	340

14. | BEARINGS AND LUBRICATION

All motors in the EOS/ZEPHYRUS range are supplied with 2RS/DDU or ZZ single row deep groove ball bearings. These bearings are lubricated for life with lithium grease and working temperature -15 ÷ + 110°C.

Note: for motors with a self-braking version, the rear bearing differs from the standard for the following sizes
EOS/ZEPH 63: 6202-2RS/DDU
EOS/ZEPH 71: 6203-2RS/DDU

EOS/ZEPH 112: 6207-2RS/DDU
EOS 56...250: deep groove ball bearing, with a crown, double-screen, lubricated for life.
EOS 280...355: re-lubricated bearings; the motors are equipped with a greaser for the necessary periodic lubrication of bearings and relevant drainage of exhausted grease (see table below).
The characteristics of the bearings for the standard motors are given in the table (tab. 1.3).

MOTOR SIZE	Front and rear bearings Horizontal IM B3, B35, B34, B5, B6, B7, B8, B14		Front and rear bearings Vertical IM V1, V15, V5, V18, V6		Bearing dimensions [Ø _e x Ø _i x H]	Sealing rings [Ø _e x Ø _i x H]
	Coupling side (Drive End)	Side opposite coupling (Non Drive End)	Coupling side (Drive End)	Coupling side (Non drive End)		
EOS/ZEPH 63b	6201-ZZ-C3	6201-ZZ-C3	32 x 12 x 10	24 x 12 x 7		
EOS/ZEPH 71b	6202-ZZ-C3	6202-ZZ-C3	35 x 12 x 11	25 x 15 x 7		
EOS/ZEPH 80b	6204-ZZ-C3	6204-ZZ-C3	47 x 20 x 14	35 x 20 x 7		
EOS/ZEPH 90S	6205-ZZ-C3	6205-ZZ-C3	52 x 25 x 15	37 x 25 x 7		
EOS/ZEPH 90L	6205-ZZ-C3	6205-ZZ-C3	52 x 25 x 15	37 x 25 x 7		
EOS/ZEPH 100L	6206-ZZ-C3	6206-ZZ-C3	62 x 30 x 16	42 x 30 x 7		
EOS/ZEPH 112M	6306-ZZ-C3	6306-ZZ-C3	72 x 30 x 19	44 x 30 x 7		
EOS/ZEPH 132M	6308-ZZ-C3	6308-ZZ-C3	90 x 40 x 23	58 x 40 x 8		
EOS/ZEPH 160L	6309-ZZ-C3	6309-ZZ-C3	100 x 45 x 25	65 x 45 x 8		
EOS 180	6311-ZZ-C3	6311-ZZ-C3	55x120x29	55x75x8/12		
EOS 200	6312-ZZ-C3	6312-ZZ-C3	60x130x31	60x80x8/12		
EOS 225 2p	6313-ZZ-C3	6313-ZZ-C3	65x140x33	60x80x8/12		
EOS 225 4-6p				65x90x10/12		
EOS 250 2p	6314-ZZ-C3	6314-ZZ-C3	70x150x35	65x90x10/12		
EOS 250 4-6p				70x90x10/12		
EOS 280 2p	6314 C3	6314 C3	70x150x35	70x90x10/12		
EOS 280 4-6p	6317 C3	6317 C3	85x180x41	85x110x10/12		
EOS 315 2p	6317 C3	6317 C3	85x180x41	85x110x10/12		
EOS 315 4-6p	NU 319 E / 6319 C3	6319 C3 / 6319 C3	95x200x45	95x120x10/12		
EOS 355 2p	6319 C3	6319 C3 / 6319 C3	95x200x45	95x120x10/12		
EOS 355 4-8p	NU 322 E / 6322 C3	6322 C3 / 6322 C3	110x240x50	110x140x10/12		

Important: in some cases, certain motors in the GM series can have bearings installed with different dimensions to those described in the catalogue. That said, this does not in any way affect the reliability and durability of the motor. In any case, the actual characteristics of the bearings are always outlined on the motor data plate.

1) The cylindrical roller bearing can only be used if the bearing is subject to constant radial load. Otherwise the motor with the ball bearing is required.

2) With high axial loads, request the motor with the angular contact ball bearing series 7...

14.1 | Maximum applicable radial loads

MOTOR	Lubrication interval [h]																Fat [g]
	Coupling side								Side opposite coupling								
	50 Hz Poles				60 Hz Poles				50 Hz Poles				60 Hz Poles				
	2	4	6	8	2	4	6	8	2	4	6	8	2	4	6	8	2 4...8
160*	3250	5450	7000	8300	2600	5000	6200	7500	3250	5450	7000	8300	2600	5000	6200	7500	13
180*	2750	5250	6750	8000	2100	4750	6000	7250	2750	5250	6750	8000	2100	4750	6000	7250	18
200*	2500	5000	6500	7700	1850	4500	5750	7100	2500	5000	6500	7700	1850	4500	5750	7100	20
225*	2250	4800	6000	7450	1500	4300	5400	6900	2250	4800	6000	7450	1500	4300	5400	6900	23
250*	2000	4650	5300	7250	1150	4150	4750	6600	2000	4650	5300	7250	1150	4150	4750	6600	26
280	2000	4300	5000	6900	1150	3800	4250	6400	2000	4300	5000	6900	1150	3800	4250	6400	26 37
315	1200	3000	4800	5500	500	2100	4000	5000	1200	3900	5750	7200	500	3500	5100	6200	37 45
355	700	2300	4300	5250	220	1600	3750	4800	700	3650	5200	6500	220	3000	4700	5900	45 60
355 X	350	1900	4100	5000	100	1750	3500	4500	700	1900	4100	5000	250	1750	3500	4500	54 86
400	350	1600	3900	4800	100	1100	3100	4300	350	3200	4800	6200	250	2600	4300	5300	54 81
450	300	1300	3500	4500	100	800	2700	4000	300	2750	4500	5800	150	1750	4000	4600	65 93

Standard motors with shielded bearings, lubricated for life; on request, for non-shielded bearings, use the table values.

1) Valid for good quality lithium grease, working temperature not exceeding 90°C, horizontal motor-shaft and nominal loads. Half the table values for applications with vertical shaft-motor.

For working temperatures over 90°C halve the values in the table every 15°C temperature increase. (Maximum working temperature, relating to lithium grease with mineral based oil, equal to approx. 110°C.

The procedures for re-lubrication of the non-shielded bearings:

If the re-lubrication interval is less than six months (approximate period), all the existing grease must however be completely replaced after 2-3 refills at the latest.

If the re-lubrication interval is longer than six months (approximate period), all the grease must be replaced every six months.

To completely replace the used grease, if the supports are accessible, it is advisable to remove the existing grease and re-lubricate the bearing manually. The free space inside the bearing should be filled with fresh grease, while the space in the support should be filled 30÷50%. The quality of the grease in the space around the bearing must not be excessive to avoid causing local raising of the temperature which would be dangerous for the grease and the bearings (pay attention not to introduce impurities in the bearing or the support).

If the supports are not accessible, it is possible to completely replace the grease using a greaser. Unscrew the drainage plug (positioned on the lower part of the support) and top up until all the exhausted grease is out of the drain. When is top-up possible with the motor running. Operation to always carry out safely, to avoid inserting in the support an excessive quantity of grease. Having reached an equilibrated temperature, screw the drain plug back on.

With very frequent lubrication intervals, you are advised to apply automatic greasing systems that greatly simplify the operation.

Regular lubrication is necessary for the life of the bearings and therefore for operation of the motor. It is recommended to use lithium grease with a good quality mineral oil base.

MOTOR SIZE	Radial forces F _r [N]			
	Dimension E [mm]	X _{max} (X=E)	X ₀ (X=0)	
	20000 hours of work			
EOS/ZEPH 56b	20	200	240	
EOS/ZEPH 63b	23	400	490	
EOS/ZEPH 71b	30	740	815	
EOS/ZEPH 80b	40	970	1120	
EOS/ZEPH 90S	50	1050	1210	
EOS/ZEPH 90L	50	1050	1210	
EOS/ZEPH 100L	60	1800	2280	
EOS/ZEPH 112M	60	1800	2280	
EOS/ZEPH 132M	80	2100	2600	
EOS/ZEPH 160L	110	2740	3540	
EOS 180	110	3385	4100	
EOS 200	110	4685	5600	
EOS 225	110	5185	6100	
	140			
EOS 250	140	6285	7700	
EOS 280	140	6000	7300	
EOS 315 S	140	170	6000	7300
EOS 315M-L	140	170	6400	7400
EOS 355	140	6550	7350	
	210			

For longer bearing lives, multiply the table loads by the following factors: 0.87 (30000 hours), 0.79 (40000 hours), 0.74 (50000 hours).

If the radial load is applied between sections XO (X=0) and Xmax (X=E) at a distance X [mm] from section XO, its maximum value Fr max can be assumed equal to:

$$F_{rmax, X} = F_{rmax, Xo} - \frac{F_{rmax, Xo} - F_{rmax, Xmax}}{E} \cdot X$$

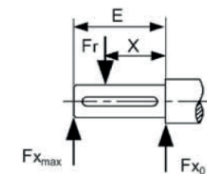

Where:

Fr_{max,X0} [N]: Maximum radial load at section XO shown in the table;

Fr_{max,Xmax} [N]: Maximum radial load at the Xmax section shown in the table; X_{max} riportato in tabella;

E [mm]: Shaft output shown in the table.

14.2 | Maximum applicable axial loads

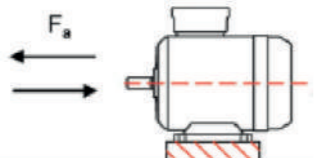
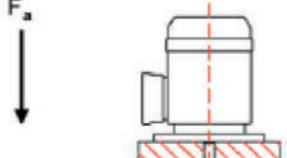
MOTOR SIZE	Axial forces F_a [N]													
														
	20.000 Hours of Work													
	Rpm speed							Rpm speed						
	750	1000	1500	3000	4000	4500	5000	750	1000	1500	3000	4000	4500	5000
EOS/ZEPH 56b	325	297	267	233	--	--	173	235	211	183	153	--	--	125
EOS/ZEPH 63b	543	493	443	393	--	--	289	407	357	307	257	--	--	216
EOS/ZEPH 71b	723	640	547	410	--	--	374	730	647	550	413	--	--	378
EOS/ZEPH 80b	980	867	732	553	--	525	--	985	878	743	562	--	532	--
EOS/ZEPH 90S	1048	927	788	593	--	561	--	1060	943	800	605	--	571	--
EOS/ZEPH 90L	1048	927	788	593	--	561	--	1060	943	800	605	--	571	--
EOS/ZEPH 100L	1785	1550	1270	883	976	--	--	1793	1562	1278	888	984	--	--
EOS/ZEPH 112M	1780	1547	1265	880	975	--	--	1795	1563	1276	890	985	--	--
EOS/ZEPH 132M	2240	1993	1677	1273	--	--	--	2274	2022	1720	1293	--	--	--
EOS/ZEPH 160L	2450	2090	2100	1910	--	--	--	2500	2127	2130	1920	--	--	--
180 M	--	--	2400	2227	--	--	--	--	--	2437	2200	--	--	--
180 L	--	2533	2387	--	--	--	--	--	2595	2438	--	--	--	--
200	--	3620	3420	2973	--	--	--	--	3422	3227	2988	--	--	--
225 S	--	--	3693	2920	--	--	--	--	--	3482	--	--	--	--
225 M	--	3673	3413	--	--	--	--	--	3385	3392	3082	--	--	--
250	--	4627	4380	4027	--	--	--	--	4317	4100	3782	--	--	--
280 S	--	--	5500	4667	3483	--	--	--	5550	4717	3567	--	--	--
280 M	--	--	--	--	--	--	--	--	--	--	--	--	--	--
315 S	--	6600	5600	3460	--	--	--	--	6633	5750	3517	--	--	--
315 M-L	--	6433	5500	3367	--	--	--	--	7167	6050	3800	--	--	--
355	--	8300	7000	3300	--	--	--	--	9210	7733	3783	--	--	--

- For operation at different speeds from those in the table, contact the SEIPEE S.p.A. technical office.
- For longer bearing lives, multiply the table loads by the following factors: 0.79 (30000 hours), 0.71 (40000 hours), 0.66 (50000 hours).

15. | DYNAMIC BALANCING

The dynamic balancing of the rotor is carried out with a half tab, in shape A, inserted in the end of the shaft. Standard "A" vibration grade; on request vibration degree "B".

The limit values for the intensity of mechanical vibrations are shown in the table. The measured values may deviate from the actual values by ± 10%.

		Dynamic balancing								
Vibration degree	Axis height Mounting	56 < H ≤ 132 [mm]			132 < H ≤ 280 [mm]			H > 280 [mm]		
		Movement [µm]	Speed [mm/s]	Acceleration [m/s ²]	Movement [µm]	Speed [mm/s]	Acceleration [m/s ²]	Movement [µm]	Speed [mm/s]	Acceleration [m/s ²]
A	Free suspension	25	1,6	2,5	35	2,2	3,5	45	2,8	4,4
Normal	Rigid assembly	21	1,3	2	29	1,8	2,8	37	2,3	3,6
B	Free suspension	11	0,7	1,1	18	1,1	1,7	29	1,8	2,8
Riduced	Rigid assembly	--	--	--	14	0,9	1,4	24	1,5	2,4

16. SOUND LEVELS

The sound tests must be performed in accordance with ISO 1680. in order to detect the sound power level (L_{WA}) and the sound pressure level (L_{pA}), i.e. the mean value of the levels, measured at 1 meter from the perimeter of the machine located in the free field and on a reflecting surface.

The EN 60034-9 standard defines the acoustic power limits to be respected and indicates the maximum sound power level (L_{WA}).

Sound pressure level L _{pA} [dB(A)] and sound power level L _{WA} [dB(A)] without applied load										
MOTOR SIZE	750rpm		1000rpm		1500rpm		3000rpm		5000rpm	
	L _{pA}	L _{WA}	L _{pA}	L _{WA}	L _{pA}	L _{WA}	L _{pA}	L _{WA}	L _{pA}	L _{WA}
EOS/ZEPH 56b	39	50	40	51	44	54	50	59	55	65
EOS/ZEPH 63b	40	51	41	52	46	55	52	63	58	69
EOS/ZEPH 71b	42	53	43	54	49	58	57	67	64	74
EOS/ZEPH 80b	44	55	46	56	51	60	61	72	70	79
EOS/ZEPH 90S	46	58	49	59	53	63	64	75	73	83
EOS/ZEPH 90L	46	58	49	59	53	63	64	75	73	83
EOS/ZEPH 100L	49	61	52	61	58	67	68	79	79	87
EOS/ZEPH 112M	53	65	54	65	60	70	69	80	80	89
EOS/ZEPH 132M	56	68	60	70	64	73	73	83	--	--
EOS/ZEPH 160L	58	71	59	71	65	76	76	86	--	--
EOS 180			80		84		88			
EOS 200			80		84		--			
EOS 225			80		85		92			
EOS 250			82		85		92			
EOS 280			85		88		94			
EOS 315			89		94		--			
EOS 355			89		--		--			

The pressure and power values shown in the table are expressed in dB(A) and refer to the motor running with no load.

The values in the table may also vary significantly depending on the type of inverter used and its programming.

SPECIAL EXECUTIONS

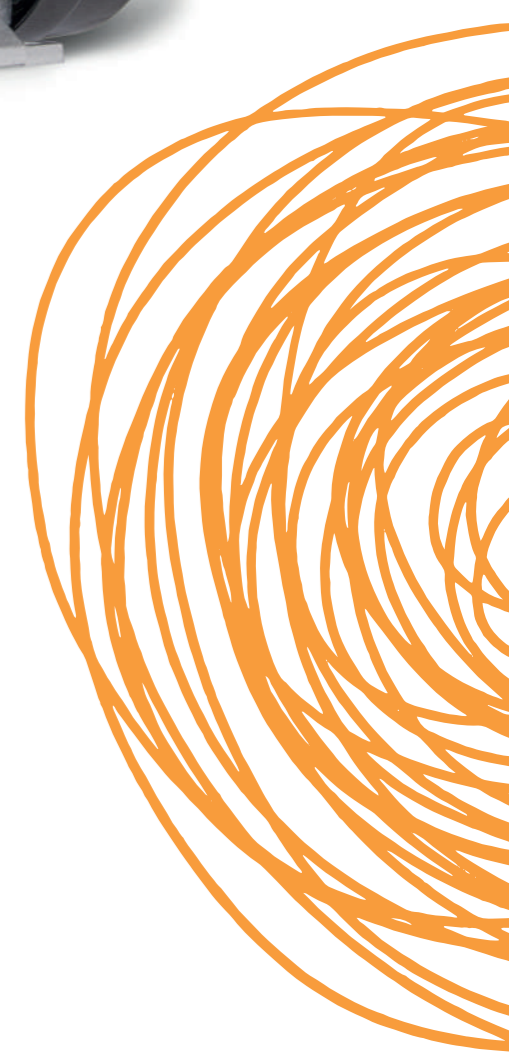

17. SPECIAL EXECUTIONS

(1) Speed transducers (options E01 + E04)

It is possible to manage different types of transducers directly assembled on the motor shaft or it is possible to supply motors with shafts prepared for different types of sensors (e.g. resolvers, incremental encoders, absolute encoders, etc.).

Standard encoder characteristics:

Bidirectional Incremental Optical Encoder	
Degree of Protection	IP54
Protection rating:	- 10 ÷ 85°C
Max Rotation Speed (Continuous Service):	4000 rpm
Resolution [pulses/rev.]:	1024
Electronic Configuration:	LINE DRIVER / PUSH PULL
Supply	5 ÷ 28 [vdc]
Output:	5 ÷ 28 [vdc]
Max current of load / channel:	20 [mA]
Zero Signal:	Si - Yes
Connector:	Tipo Mil - Mil Type

For further information contact the iMotor Srl technical office.

(3) PT 100 temperature sensor (resistance thermometer) (option T02)

Compliant with DIN-IEC 751 standards. It is a temperature sensor that exploits the resistivity variation of some materials when the temperature changes. They must be connected to a special equipment (the purchase of this equipment is at the expense of the purchaser of the motor).

Winding: No. 3 PT100 inserted in the winding one per phase. Terminals located inside the motor terminal box.

(4) KTY variable resistance silicone thermal sensor (option T03)

Temperature sensor dependent on resistance variation with positive temperature coefficient
WARNING: respect the power supply polarity to avoid damage to the sensor itself.

(5) Anti-condensation heater (option T04)

It is recommended for motors operating in environments:

- with high humidity;

(2) Bimetal thermal probes (PTO) NC 150°C (option T01)

Characteristics: $V_{nmax} = 250V$; $I_{nmax} = 1.6A$.
Three probes connected in series with normally closed contact (NC) inserted in the motor winding. The contact opens when the winding temperature reaches and exceeds the intervention value. Terminals located inside the motor terminal box.

- with strong temperature range;
- with low temperature (possible ice formation).

Resistance fixed on coil heads which allows you to heat the stationary electric motor and thus avoid the formation of condensation inside the casing.

Single-phase power supply 230V ac $\pm 10\%$ 50/60Hz, power consumption:
25 W for size 56 ... 90
26 W for size 100 ... 112
40 W for size 132 ... 160

Terminals located inside the motor terminal box. Mandatory execution: Condensate drain holes.

If, during installation, the condensation drain holes located on the underside of the electric motor have not been removed, they must be opened approximately every 5 months.

The heater must not be powered while the motor is running

(6) Condensation drain holes (option T05)

When ordering, always specify the working position of the motor.

(7) Additional winding impregnation (option A01)

It consists of a second impregnation cycle; it is recommended:
in humid and corrosive environments (moulds); when a higher winding protection is desired; in the presence of strong stresses (induced mechanical or electromagnetic vibrations);

(7) Class H winding (option A02)

Class H insulation system, made of double-enamelled class H copper wire. Impregnation system with high quality class H resins. Accurate separation of the phase windings (in the groove and in the head), accurate insulation of the "braid" (phase start cables). Other class H materials

(8) IP56 protection (IP56 option)

Motor protected against dust (first digit) and water jets (second digit). The protection rating on the rating plate becomes IP56.
For further information, please refer to the CEI EN 60034-5 standard.
Protection rating NOT feasible with brake option.

(9) IP65 protection (IP65 option)

Motor hermetically protected against dust (first digit) and water jets (second digit). The protection rating on the rating plate becomes IP65.
For further information, please refer to the CEI EN 60034-5 standard.
Protection rating NOT feasible with brake option.

(10) IP66 protection (IP66 option)

motor hermetically protected against dust (first digit) and waves of water or very strong jets (second digit). The protection rating on the rating plate becomes IP66.
For further information, please refer to the CEI EN 60034-5 standard.
Protection rating NOT feasible with brake option

(11) Manual rotation (option R01)

It allows you to turn the crankshaft from the opposite command side. A hexagonal male wrench is used by inserting it into the central hole of the fan cover:
Measure of 3 for sizes 56 and 63
Measure of 4 for 71
Measure of 5 for 80
Measure of 6 for 90 ÷ 132
Measure of 8 for 160

The manual rotation option cannot be performed with the following executions:
Rain cover;
Encoder;
Axial servo-fan.

(12) Special painting (options C1 + C5M)

The choice of painting treatment is a critical phase as it depends on the durability of the electric motor according to the environment in which it is to be placed.
According to the UNI EN ISO 12944-1 standard, durability can be classified according to 3 classes:
Low (L) from 2 to 5 years
Average (M) from 5 to 10 years
High (H) over 15 years

Durability is indicated next to the corrosivity category of the installation environment to allow the definition of the protection cycle able to operate in that environment and to ensure the required durability. The painting cycles that are carried out are fully compliant with the regulations.
Classification of environments:
C1 - C2 = Rural areas, low pollution; heated buildings/neutral atmosphere.
C3 = Urban and industrial atmospheres; moderate sulphur dioxide levels; production areas with high humidity.
C4 = Industrial and coastal areas; chemical processing plants.
C5L = Industrial areas with high humidity and aggressive atmospheres.
C5M = Marine areas, offshore areas, estuaries, coastal areas with high salinity.

(13) Terminal box position (option S01)

It is normally supplied for motors equipped with IM B3 and derivative feet, observing from the shaft output side:
T Position is standard (top);
R position on request (on the right);
L position on request (on the left)

Any brake release lever follows the position of the terminal box.



(14) Rain cover (option P01)

Execution required for outdoor applications or in the presence of water splashes, with vertical shaft pointing downwards, type of construction (IM V5, IM V1, IM V18, IM V15, IM V17).
The LB dimension increases by:
35 mm size 56÷112
45 mm size 132÷160
65 mm grandezza 180÷225
85 mm grandezza 250÷355

(15) ATEX (option EX)

EOS and ZEPHYRUS series iMotor branded motors are supplied for use in environments with potentially explosive atmospheres according to **ATEX directive 2014/34/EU group II category 3D zone 22/3G zone 2**

Plate marking (standard executions)

-  **II 3 D Ex tc IIIC T135°C Dc IP65;**
-  **II 3 G Ex ec IIC T3 Gc.**

On request, the following is possible  **II 3 G Ex nA IIC T4 Gc;**

Legend:

II = Group of origin (use on surface);

3 = Protection category according to Directive 2014/34/EU;

D = Dust per installation zone Dc (zone 22);

G = Gas per installation zone Gc (zone 2);

tc/ec = Protection mode;

IIIC/IIC = Equipment group of origin according to the nature of the explosive atmosphere;

T135°C = Maximum surface temperature for atmospheres with presence of dust;

T3/T4 = Temperature class for atmospheres with presence of gas.

For inverter applications, it is always necessary to connect the supplied probes to meet the thermal classes indicated in the marking.

The purchaser of the product will be responsible for taking appropriate technical and organisational measures and for assessing any possible risk of explosion to the health and safety of workers in potentially explosive areas (Directive 99/92/EC). On receipt of the electric motor, make sure there is no damage or faults. Before starting the motor, check the data on the plate, read the instruction manual carefully (supplied to the motor) and verify its suitability for the application requested.

*Exclusively for the motor series with brake.

(16) Manual release lever* (option F02)

It frees the motor from the unpowered brake and returns to its initial position after the manoeuvre (automatic return). Useful to carry out manual rotations if the power supply is cut and/or during installation. The handle of the lever can be removed and is located in correspondence with the terminal box (standard position). For different positions, contact us. It is always advisable to remove the handle once the operations have been completed.

(17) Rubber brake protection* (option F03)

It is used to prevent dust and/or water or other foreign bodies from entering the braking surfaces. It also considerably limits the brake wear dust to the environment. It is applied around the brake in the appropriate slots provided.

This execution is necessary for IP55.

(18) IP55 protection* (option F04)

Not possible in execution with release lever.

SAFETY WARNINGS



SAFETY WARNINGS



ATTENTION!

Read all warnings and instructions below and **consult the Use and Maintenance manual and the Technical Catalogue**, available on our website or on request, before proceeding to use the product



GENERAL WARNINGS

Strictly comply with legislation in force and all applicable standards on safety and correct installation and the information outlined in the following manual as an incorrect

procedure could cause damage to property, people and animals. In the event of doubt or misunderstanding, immediately shut-off the works and contact the SEIPEE SpA technical office.



Low-voltage rotating electrical machines contain live parts, rotating or moving parts, surface and interior parts with temperatures above 50°C in normal operation.

All transport, installation, commissioning, maintenance and repair operations must be carried out by qualified personnel and checked by the responsible experts.



Improper use of the motors and/or removal or disconnection of the protective devices can cause serious damage to people, animals and property.

We therefore decline all liability in case of accidents and/or damage due to negligence and/or failure to follow the instructions described and the general safety regulations or use under conditions other than those indicated on the plate.

We also decline all liability for damage caused by improper use of the motors and/or the removal or disconnection of the electrical and mechanical protections.



The three-phase permanent magnet synchronous motors described in this manual cannot function directly connected to the power supply and for this reason it is necessary to use an inverter.

These motors are designed to be used at room temperature $-15 \div +40^{\circ}\text{C}$ and with a maximum altitude of 1000m above sea level in accordance with CEI EN 60034-1. Any conditions other than those described above are indicated on the plate.



Pay attention to the values on the plate, and check that the conditions of use are compatible with the information shown.

EOS & ZEPHYRUS series three-phase permanent magnet synchronous motors are intended to be incorporated, the motor cannot be put into service until the machine in which it is to be incorporated has been declared compliant with the applicable provisions.



This manual refers to the three-phase permanent magnet synchronous motors of the EOS & ZEPHYRUS series which is not allowed to be used in explosive atmospheres.

It is important to pay attention to the difference in operation between the motor and the generator, as described below:



OPERATION AS GENERATOR

Dragging the crankshaft produces a voltage at the terminals of the stator winding, the value of which is proportional to the dragging speed of the crankshaft.



OPERATION AS MOTOR

For operation as a motor, you must use an inverter suitable to control motors with rotor with permanent magnets. These devices use different control methodologies of the motor performance, **therefore based on the type of inverter, you can have slight thermal variations and differences in the data outlined on the plate.**

Check that the motors are intact and undamaged before using them.

The motors are unambiguously identified by the plate placed on the product that outlines the main technical characteristics, the CE marking and the manufacturer's data and serial number. The motors must be raised and handled using appropriate accident prevention devices at all times and in accordance with current legislation, if necessary, use the **specific eyebolts** supplied with the motor, paying attention not to damage the auxiliary equipment and the connection cables to the motor. Do not lift the motor, when connected to other components, using its eyebolts.

The motor must be positioned away from the humidity, since, in its presence, the insulation of the machine can decrease very rapidly until it becomes almost null.

Always disconnect the motor from the power supply before operating on it or on the equipment connected to it.

NOTE

NOTE

BRUSHLESS MOTORS

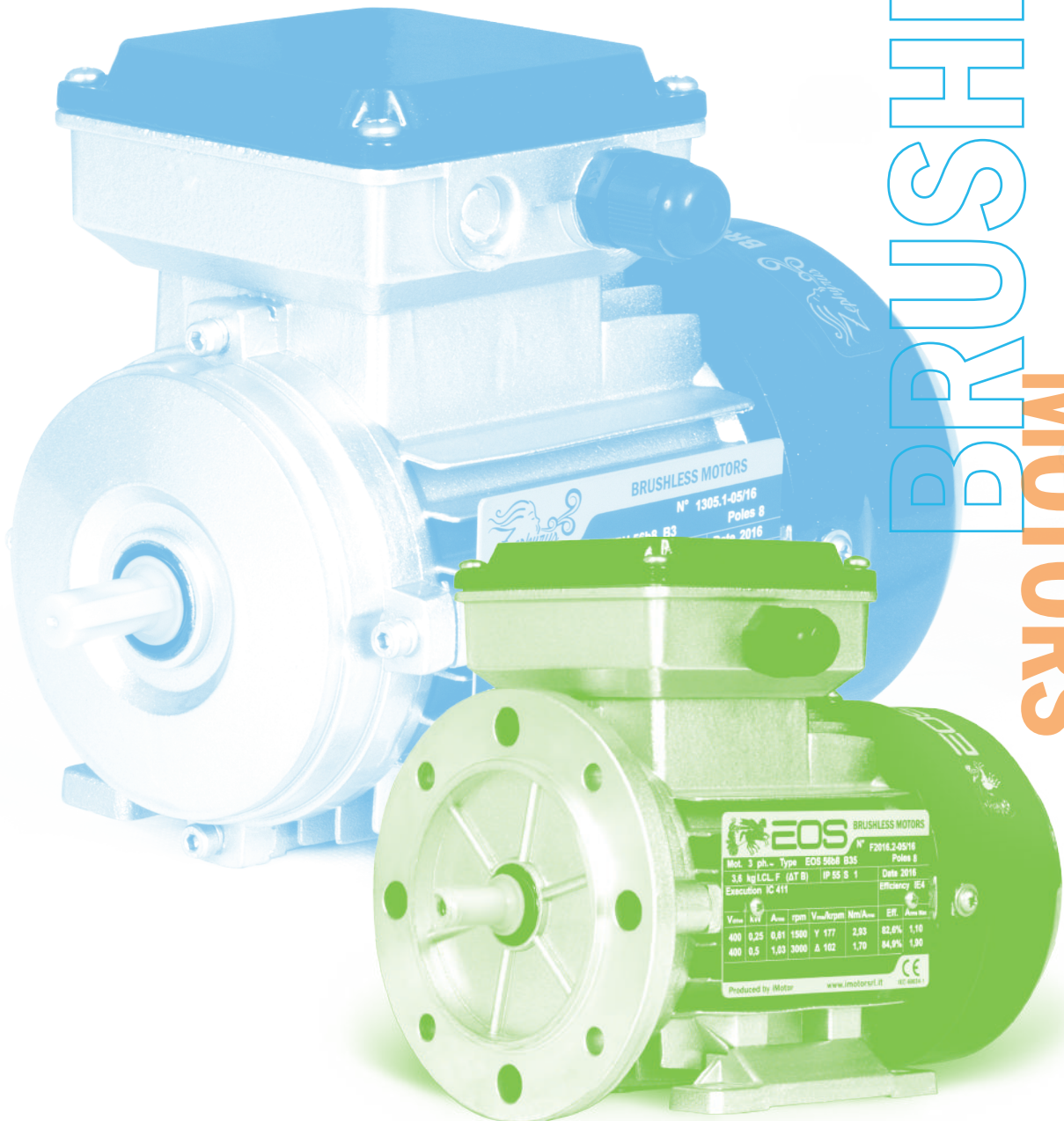

iMotor by Seipex S.p.A.

Via Ferrari, 4 - 41011 Campogalliano (MO) - Italy Tel. +39.059.8676828 - Fax. +39.059.8676922
 sito internet: www.imotorSrl.it - e-mail: info@imotorSrl.it